

Considerations When Configuring and Selecting Cables for Microphone Systems

With the growing demand of recent years for both greater physical comfort and savings in energy consumption, systems incorporating digital control based on the latest advances in electronics are coming into wider use for air conditioning and lighting systems. As all these systems come on line, we cannot help but be reminded of the fact that the wiring used for these digital control systems generates pulse-based electromagnetic noise of the kind that affects the very delicate signals used in microphone lines.

Microphone cables are designed to carry a range of signals that span the spectrum from 1/100 of a volt (10 mV) to 1/1,000,000 (1 μ V). One small error in wiring procedure or cable selection and the entire microphone system turns into an antenna collecting the surrounding noise.

The following section uses a question and answer format to cover a list of the essential points for configuring microphone systems.



Q1 Under what sort of conditions should a two-conductor microphone cable be used?

The two-conductor microphone cable is suited to environments where noise is not such a great factor and the audio signals are in the comparatively high -20 dB to 0 dB level range. In such cases, the two-conductor cable offers the advantages of smaller diameter and lower cost. Of course if microphone level, rather than line level, is the criterion being used, star quad cable should be used instead.

Q2 Under what conditions should star quad microphone cable be used?

This type is used for environments with a higher noise factor and where audio signals are in the low -50 dB or less range. This type of cable performs well under noise conditions that exceed the capacity of the two-conductor shielded cable, effectively shielding out over ninety percent more noise. (See Figs. 1, 2)

However, should this type be routed alongside a power cable of any significant capacity it should probably be encased in metal conduit just to be safe.

Q3 Isn't star quad cable expensive?

The cost for this type of cable has fallen significantly in recent years. Several decades ago, cost was so prohibitive a factor that only large musical auditoriums and broadcasting facilities could afford them. Canare succeeded in developing a low-cost star quad cable using aluminum foil in 1981. In addition to traditional professional facilities, this type gained wide use in such non-traditional areas as wedding halls and school lecture rooms.

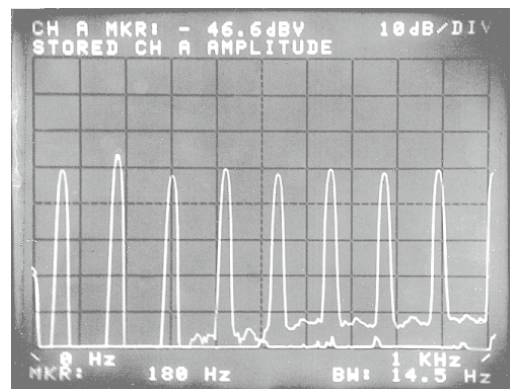

Fig. 1 Noise induced in two-conductor shielded cable (MVVS)

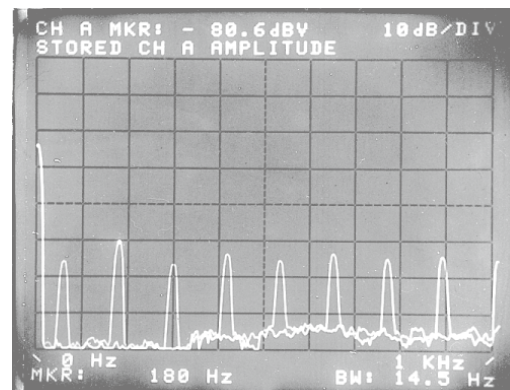
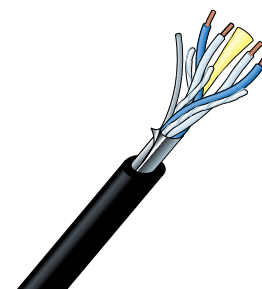

Fig. 2 Noise induced in star quad cable (Canare L-4E5AT)

<Test conditions>

1. Flush along power cables for 20 m distance
2. Power cable connected to lighting fixture dimmed to 50% capacity with load of 1 kW.
3. The noise induced in the audio cable was boosted by 50 dB in the head amplifier and viewed on a spectrum analyzer.



Star quad cable with aluminum foil shield

Q4 When avoiding use of metal conduit, how far away should microphone cable be from power cables?

When foregoing the use of protective metal conduit, use the graph shown in Fig. 3 as a general guide for distancing cables. Note that ignoring basic guidelines for positioning cables can easily result in noise induction problems which are very difficult to deal with later. Encasing microphone cables in metal conduits is highly recommended for applications that utilize the delicate signal range.

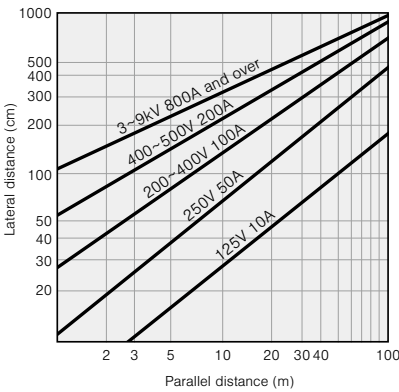

Fig. 3 Distances for positioning microphone and power cables

<Requisite conditions>
 1. Cables are the star quad type.
 2. Power cables are in the circular cab tire configuration.

Q5 What considerations are required when using a rack for strong electric current?

The same as for the preceding question when metal conduit is not used.

Q6 Would there be any problem with routing the cables through a flexible metal conduit?

The flexible conduit would certainly help to reduce noise but would not be as effective as a rigid metal conduit. Use the graph in Fig. 4 as a guide for distancing cables.

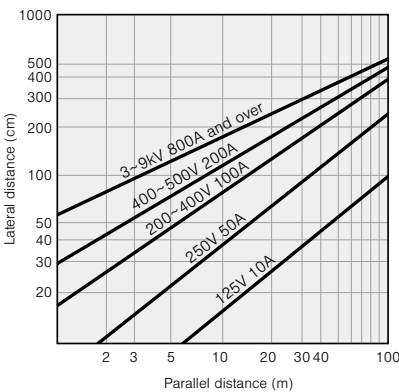

Fig. 4 Distances for positioning microphone and power cables when routing microphone cables via flexible metal conduit

<Requisite conditions>
 1. Cables are the star quad type routed through flexible metal conduit.
 2. Metal conduit is grounded using appropriate level of resistance.
 3. Power cables are in the circular cab tire configuration.

Q7 What are the criteria for choosing between the many different types of microphone cables?

As all are designed to provide electromagnetic shielding there is not that much basic difference in shielding performance. However, they do differ in various specific characteristics. Cable type should be selected according to specific requirements. (See Fig. 5)

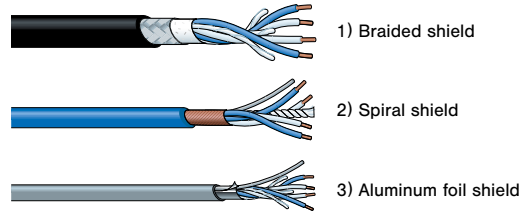

Fig. 5 Types of star quad microphone cables

• Braided Shield

The braided copper shield is designed to maintain effective shielding performance, regardless of how many times the cable is unwound, bent, twisted or rewound. It is ideal for use as handheld microphone cables or extension cables. This type is more expensive than other types as it is braided very finely to ensure a highly impenetrable shield. Cable termination requires seasoned expertise.

• Spiral Shield

The spiral shield consists of several copper wires wound tightly around the cable in a spiral wind. The shielding effect is heightened by winding the shield on twice, each time from different directions in what is referred to as the "double-spiral shield." The cost range for the spiral shield cable lies roughly mid way between the braided shield and the aluminum foil shield cable. Although cable termination operations are comparatively simple, the spiral shield tends to deteriorate when flexed too frequently. It is designed for stationary installation.

• Aluminum Foil Shield

The aluminum foil shield cable consists of aluminum foil fused onto a polyester film and wound around the cable in the form of a tape. Cable termination involves a simple operation and the cable is relatively inexpensive. The aluminum foil cable is recommended for use as stationary cabling.

Aluminum foil cable with a Kevlar cable filler is highly recommended for areas where cables will be routed through metal conduit. The Kevlar filler protects the cable as it passes through the conduit, preventing cable breakage or shorting, even when intense stress is applied to the cable. The aluminum foil cable is currently widely used in function halls and multipurpose track and field stadiums.

AWG is for Indicating conductor size

AWG stands for American Wire Gauge. While it is primarily used in North America, it is widely recognized internationally. For solid conductors, the AWG number corresponds to the diameter, whereas for stranded conductors, it is determined by the cross-sectional area. Table 1 provides a list of typical AWG sizes for Canare cables. Complete AWG details can be found on each cable's product page.

Type	Solid Conductor			Stranded Conductor		
	Diameter (mm)		Canare Model	Cross Sec Area (mm ²)		Canare Model
AWG	Nominal	Minimum		Nominal	Minimum	
25	0.455	0.450		0.162	0.159	MR202-AT, DA202
24	0.511	0.506		0.205	0.201	L-4E6S, LV-61S
23	0.574	0.569	L-2.5CHD	0.259	0.254	L-2T2S
22	0.643	0.635		0.324	0.318	DMX203, LV-77S, L-3.3CUHWS
21	0.724	0.716	L-3.3CUHD	0.412	0.404	
20	0.813	0.805		0.519	0.509	4S6, L-4.5CHWS
19	0.910	0.904		0.653	0.641	
18	1.020	1.016	L-4.5CHD	0.823	0.807	GS-6
17	1.150	1.140		1.040	1.020	
16	1.290	1.278	L-5.5CUHD	1.310	1.280	4S8, 2S7F, L-5.5CUHWS
15	1.450	1.435		1.650	1.620	
14	1.630	1.613		2.080	2.040	4S11, 2S9F
13	1.830	1.800	L-8CUHD	2.630	2.580	
12	2.050	2.030		3.310	3.240	2S11F

< Table 1 >

Cables

Star Quad Cables

The Star Quad Story

Canare Star Quad obtains its name from the 4-conductor style construction that minimizes the "loop area" between twists of the conductors. This "double balanced" pairing, reduces susceptibility to electromagnetically induced noise. The improvement in noise rejection is so noticeable, that even SCR dimmer noise (stage lighting consoles), is reduced to less than 1/10 the level found in other 2-conductor microphone cables.

Canare Star Quad is designed for use with microphones but is also excellent for all line-level signals (e.g. mixer to power amps). The 4-conductor Star Quad arrangement, cancels electromagnetically

induced noise from SCR dimmer packs, fluorescent lighting ballasts and AC power transformers. Handling noise is prevented by use of cotton filler material. Excellent frequency response is maintained due to special irradiated polyethylene insulation which provides a low capacitance dielectric.

Canare Star Quad cable with braided shields is super flexible. We use large numbers of thin wire strands in the copper conductors and overall braided shield. We extrude a special compound PVC outer jacket that remains pliant at extremely low temperatures with no wait between cold shipping and installation.

Filler

Canare selects cotton, jute and /or exotic polyester fibers for packing. These fillers prevent stretching and twisting of the inner conductors which can cause noise. Additionally, paper, Mylar and/or cloth tape, bind conductors so cables hold their shape.

Shield

Canare does not use spiral (serve) shields because they can spread apart with use. Our shields are more difficult to manufacture because we use many thin copper strands in a densely woven braid. The shields are super flexible and offer outstanding noise rejection.

Conductors

All Canare microphone cables utilize high-conductivity, annealed copper wires, stranded to form flexible conductors and shields.

Insulation

Canare cables utilize special polymer compounds that reduce capacitive "R-C" filter roll off within the cable and prevent high voltage breakdown. By irradiating the material, the polymer becomes extensively cross-linked, chemically inert, water resistant, and remains flexible at very low temperatures. Irradiated PE is superior to ordinary polyethylene because it is heat resistant. Canare insulation will not shrink back, flow or char when soldering, so you save initial and rework time, and achieve more reliable connections.

Jacket

Canare uses specially formulated PVC compounds that combine to make a tough, strong and durable outer jacket with excellent flexibility. These qualities are retained even at very low temperatures, so Canare cables will not stiffen or crack. Available in 10 attractive colors.

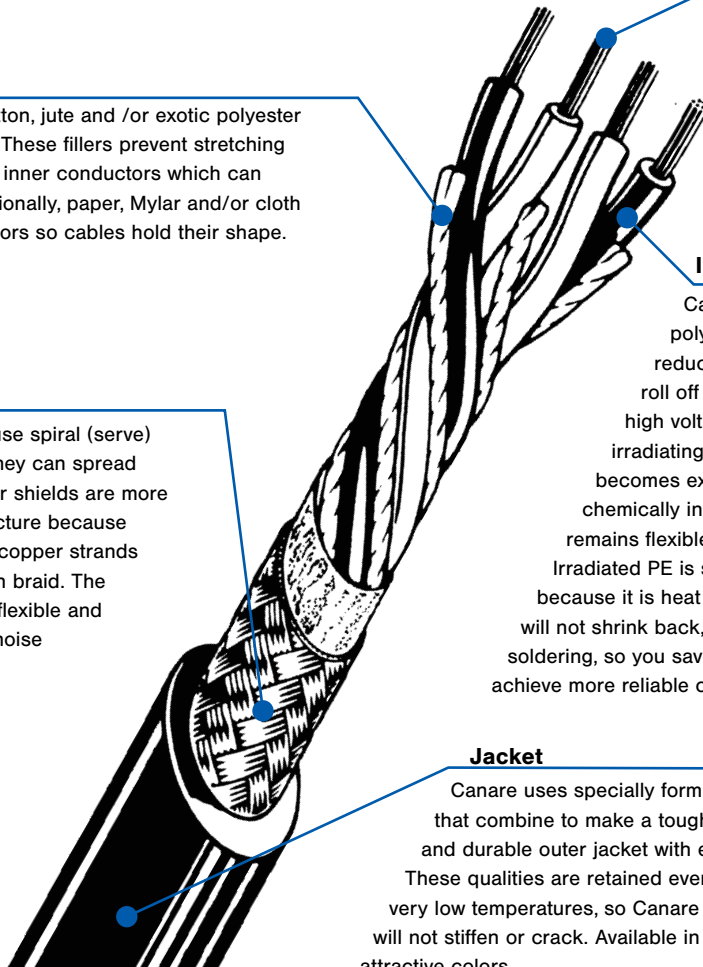

In order to maximize noise rejection, Star Quad must be properly wired to the XLR-3 connector (or terminal block).

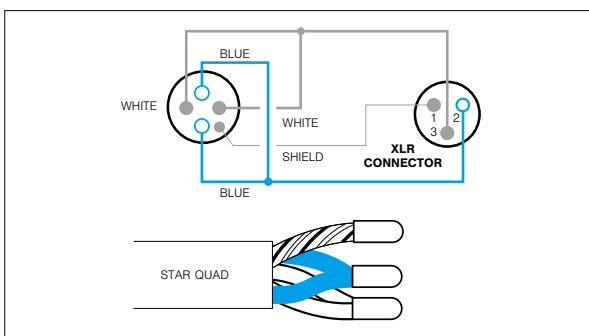

Because the shield density on Canare Cable is very high, it is somewhat difficult to push back the braid and pull the inner conductors through. Instead, we strongly recommend unbraiding the shield by "combing" it out with a pointed tool, beginning at the end of the cable.

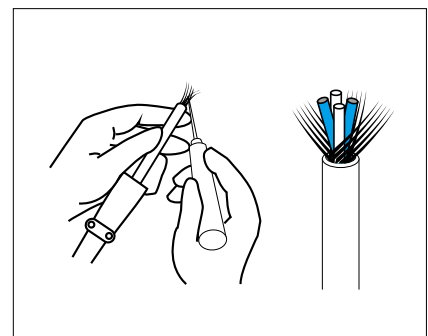

Star Quad Microphone Cables (Single)



Effectively reduce noise levels to 1/10 that of general-purpose, 2-conductor shielded cables.

Aluminum Foil Shield

Type	Model	Sales units	Nom. O.D.	Weight	Composition			Electrical characteristics				
					No. of cond.	Cross sec. area (AWG) and cond. comp.	Twist pitch	Shield	Cond. DCR	Shield DCR	Nom. cap.*	Nom. cap.**
		m	mm	kg/100m		mm ² /(AWG) Q'ty/mm	mm		Ω/100m	Ω/100m	pF/m	pF/m
	L-4E3AT	200 500	3.0	1.2	4	0.08(28) 7/0.12A	16	AL foil	24.6	—	—	—
	L-4E5AT	100 200 400	5.0	3.3	4	0.18(25) 16/0.12A	21	AL foil	10.7	—	164	222
	L-4E5ATG		5.0	3.3	4	0.18(25) OFC 1/0.18+30/0.08	21		11.1	—	164	222
	L-4E6AT		6.2	5.0	4	0.31(23) 12/0.18A	25		6.4	—	150	210
	L-4E6ATG		5.8	4.6	4	0.34(22) OFC 1/0.18+63/0.08	35		5.5	—	150	210
	L-4E5AT-WBS	100 200 400	6.8	8.9	4	0.18 (25) 16/0.12A	21	AL foil + double braid	10.7	—	164	222
	L-4E6AT-WBS	100 200 400	8.6	12.3	4	0.31 (23) 12/0.18A	25	6.4	—	150	210	

Insulation: Cross-linked PE Jacket: PVC Dielectric strength: 500V AC/min.

*Capacitance between conductors **Capacitance between conductor and shield.

L-4E*AT Series

- Designed for fixed installations
- Aluminum foil shielding provides 100% coverage
- DuPont Kevlar* filler can resist stretching of cable when pulled through conduit. (excluding L-4E3AT)
- Foil shield and drain wire offer quick assembly work
- L-4E*ATG has an OFC conductor
- L-4E*AT-WBS has a high-density double-braided shield. Its foil and braided shield are insulated by inner jacket.

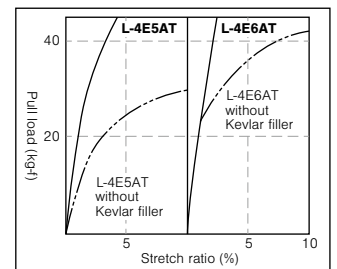
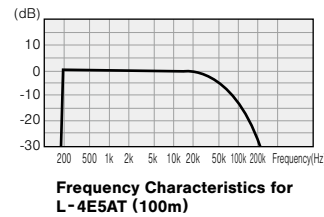

Braided Shield

Type	Model	Sales units	Nom. O.D.	Weight	Composition			Electrical characteristics				
					No. of cond.	Cross sec. area (AWG) and cond. comp.	Twist pitch	Shield Coverage (braid)	Cond. DCR	Shield DCR	Nom. cap.*	Nom. cap.**
		m	mm	kg/100m		mm ² /(AWG) Q'ty/mm	mm	%	Ω/100m	Ω/100m	pF/m	pF/m
	L-4E5C	100 200	4.8	3.4	4	0.15(26) 30/0.08A	18	96%	13.0	2.4	162	200
Jacket colors for L-4E5C: BLK RED ORN YEL GRN BLU GRY	L-4E6S		6.0	4.8	4	0.20(24) 40/0.08A	20	94%	9.8	3.1	150	185
	L-4E5	100 200	4.8	3.5	4	0.15(26) 30/0.08A	18	96%	13.0	1.9	162	200
Jacket colors for L-4E5: BLK BRN RED ORN YEL GRN BLU PPL GRY WHT	L-4E6	100 200 400	6.5	6.1	4	0.23(24) 20/0.12A	25	96%	8.6	1.6	144	187

Insulation: Cross-linked PE Jacket: PVC Dielectric strength: 500V AC/min.

*Capacitance between conductors. **Capacitance between conductor and shield.

L-4E5C, L-4E6S

- Bend resistant design: the conductor consists of ultrafine 0.08 mm strands offers excellent durability.
- High-density braided shield

L-4E5, L-4E6

- High-density braided shield
- Drain wire included

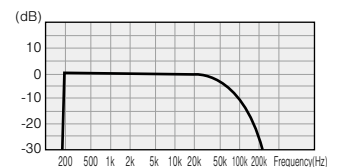

Frequency Characteristics for L-4E6S (100m)



Multichannel Star Quad Microphone Cables

Aluminum Foil Shield

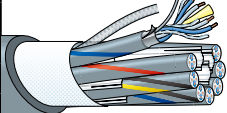
Type	Model	No. of ch.	Sales units	Nom. O.D.	Weight	No. of cond.	Unit composition			Electrical characteristics			
							Cross sec. area (AWG) and cond. comp.	Twist pitch	Ch. O. D.	Cond. DCR	Shield DCR	Nom. cap.*	Nom. cap.**
							mm ² /(AWG) Q'ty/mm	mm	mm	Ω/100m	Ω/100m	pF/m	pF/m
 L-4E4-8AT Jacket color: GRY	L-4E3-2AT	2	100 200 500	8.5	7.3	8	0.08(28) 7/0.12A	16	3.0	24.8	—	—	—
	L-4E3-4AT	4		10.0	11	16							
	L-4E3-8AT	8		13.8	19	32							
	L-4E3-12AT	12		15.6	26	48							
	L-4E3-16AT	16		17.2	32	64							
	L-4E3-24AT	24		21.3	47	96							
	L-4E4-2AT	2		10.5	12	8	0.18(25) 16/0.12A	21	3.7	10.8	—	164	222
	L-4E4-4AT	4		12.3	17	16							
	L-4E4-8AT	8		16.9	31	32							
	L-4E4-12AT	12		18.9	41	48							
	L-4E4-16AT	16		20.9	50	64							
	L-4E4-24AT	24		26.1	76	96							

Insulation: Cross-linked PE (blue-blue, white-white) Jacket, inner Jacket: PVC Dielectric strength: 500V AC/min. *Capacitance between conductors **Capacitance between conductor and shield.

L-4E3-**AT, L-4E4-**AT

- The multichannel microphone cable is the cable of choice for music auditorium and studio facilities where noise prevention and audio quality are the prime considerations.
- Each unit contains the highly pull-resistant Kevlar* cable filler.
- *Kevlar is a trademark of DuPont.
- Drain wire included in each unit.

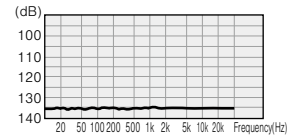
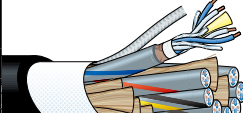

Fig. 1 Crosstalk Characteristics for L-4E4-4AT (100m)

Braided Shield

Type	Model	No. of ch.	Sales units	Nom. O.D.	Weight	No. of cond.	Unit composition			Electrical characteristics				
							Cross sec. area (AWG) and cond. comp.	Twist pitch	Shield coverage (braid)	Ch. O. D.	Cond. DCR	Shield DCR	Nom. cap.*	Nom. cap.**
							mm ² /(AWG) Q'ty/mm	mm	%	mm	Ω/100m	Ω/100m	pF/m	pF/m
 L-4E3-8P Jacket color: BLK (L-4E3-2H GRY)	L-4E3-2H	2	100 200 500	8.9	9.5	8	0.08(28) 7/0.12A	16	93%	3.4	24.9	3.4	145	170
	L-4E3-2P	2		8.9	8.2	8								
	L-4E3-4P	4		10.9	13	16								
	L-4E3-8P	8		15.3	26	32								
	L-4E3-12P	12		17.4	36	48								
	L-4E3-16P	16		18.9	46	64								
	L-4E3-24P	24		24.0	70	96	0.15(26) 30/0.08A	18	95%	4.0	13.1	2.4	162	200
	L-4E4-2P	2		11.1	13	8								
	L-4E4-4P	4		13.4	21	16								
	L-4E4-8P	8		18.2	34	32								

Insulation: Cross-linked PE (blue-blue, white-white) Jacket, inner jacket: PVC Dielectric strength: 500V AC/min. *Capacitance between conductors **Capacitance between conductor and shield.

L-4E3-2H, L-4E3-**P, L-4E4-**P

- Ideal multichannel cable for PA and live events where cables are laid down and taken back up on a regular basis.
- Each unit of L-4E3-2P and L-4E3-2H contains the highly pull-resistant Kevlar* cable filler.
- *Kevlar is a trademark of DuPont.
- The L-4E3-2H is the reinforced version containing a stainless steel wire support.

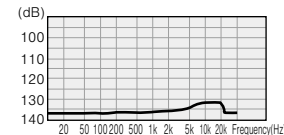



Fig. 1 Crosstalk Characteristics for L-4E4-4P (100m)

Cross-sectional View

Single unit config.

Aluminum foil shield



Braided shield

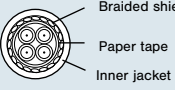

2ch



4ch



8ch



12ch



16ch



24ch



Channel color code: Spiral marks on inner jacket (gray).

Unit no.	1	2	3	4	5	6	7	8	9	10	11	12	13	14	15	16	17	18	19	20	21	22	23	24
Spiral mark	RED	BLU	YEL	GRN	BRN	-	BLU/BLK	YEL/BLK	GRN/BLK	BRN/BLK	BLK	BLU/ORN	YEL/ORN	GRN/ORN	BRN/ORN	ORN	BLU/PNK	YEL/PNK	GRN/PNK	BRN/PNK	PNK	BLU/WHT	YEL/WHT	GRN/WHT



Two-Conductor Shielded Cables (Single)

Aluminum Foil Shield

Type	Model	Sales units	Nom. O.D.	Weight	Composition			Electrical characteristics			
					No. of cond.	Cross sec. area (AWG) and cond. comp.	Twist pitch	Cond. DCR	Shield DCR	Nom. cap.*	Nom. cap.**
						mm ² /(AWG) Q'ty/mm	mm	Ω/100m	Ω/100m	pF/m	pF/m
 Jacket colors: GRY BLK	L-2B2AT	200 500	3.2	1.3	2	0.18(25) 16/0.12A	25	10.5	—	66	120
 Jacket color: GRY	L-2B2AL	200	3.2	1.1	2	0.18(25) 7/0.18TA Overall tin coated	20	11.3	—	—	—
 Jacket colors: GRY BLK SEPIA	L-2E5AT	200	5.0	3.3	2	0.31(23) 12/0.18A	30	6.2	—	68	140
 Jacket color: GRY	L-2E5AL	200 500	5.0	3.7	2	0.29(23) 7/0.23TA Overall tin coated	30	6.8	—	—	—

Insulation: Cross-linked PE (polyethylene for L-2E5AL and L-2B2AL) Jacket: PVC Dielectric strength: 500V AC/min. *Capacitance between conductors **Capacitance between conductor and shield.

L-2B2AT, L-2E5AT

- Ideal for internal rack wiring.
- Drain wire included.
- The L-2E5AT contains the Tetoron cable filler reinforcement material. <Fig. 1>

L-2B2AL, L-2E5AL

- Cables for connecting devices with which wrapping tools can be used.
- Drain wire included.

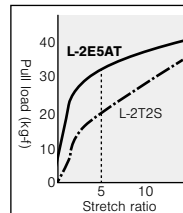

Fig. 1 Pull Load and Stretch Ratio for Cable

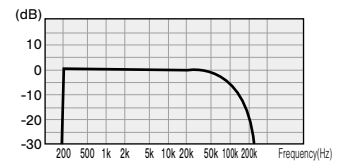

Fig. 2 Frequency Characteristics for L-2B2AT (100m)

Braided Shield

Type	Model	Sales units	Nom. O.D.	Weight	Composition			Electrical characteristics				
					No. of cond.	Cross sec. area (AWG) and cond. comp.	Twist pitch	Shield coverage (braid)	Cond. DCR	Shield DCR	Nom. cap.*	Nom. cap.**
						mm ² /(AWG) Q'ty/mm	mm	%	Ω/100m	Ω/100m	pF/m	pF/m
 L-2T2S Jacket colors: L-2T2S: BLK RED ORN YEL BLU GRY L-2E5: BLK	L-2T2S	100 200	6.0	4.6	2	0.30(23) 60/0.08A	20	94%	6.5	3.1	60	106
	L-2E5	200	4.6	3.0	2	0.15(26) 30/0.08A	18	97%	12.7	2.2	63	117

Insulation: Cross-linked PE Jacket: PVC Dielectric strength: 500V AC/min. *Capacitance between conductors **Capacitance between conductor and shield.

L-2T2S, L-2E5



- Braid coverage of 94% and above provides dense shielding that blocks out electromagnetic noise.
- L-2T2S consists of 60 ultra-fine 0.08 mm strands (30 for L-2E5) in a stranded format that offers excellent durability.
- Highly pliable and durable PVC used for jacket. (Brittle temp. -49°C)

Technical Trend
IP Connectivity Products
Fiber-Optic Systems
Connectors
Cables
Panels & Patchbays
Multichannel Systems
Cable Assemblies

Cables

Two-Conductor Shielded Cables

■ Spiral Shield

Type	Model	Sales units	Nom. O.D.	Weight	No. of cond.	Composition			Electrical characteristics			
						Cross sec. area (AWG) and cond. comp.	Twist pitch	Shield coverage	Cond. DCR	Shield DCR	Nom. cap.*	Nom. cap.**
						mm ² /(AWG) Q'ty/mm	mm	%	Ω/100m	Ω/100m	pF/m	pF/m
 MS202 Jacket color: BLK	MS202	200	2.8	1.4	2	0.18 (25) 1/0.18TA + 30/0.08TA	25	91% (spiral)	11.3	3.2	74	145
 MS203 Jacket color: GRY		200	3.5	2.1	2	0.31(23) 12/0.18TA	30	91% (spiral)	6.5	2.3	—	—

Insulation: Cross-linked PE Jacket: PVC Dielectric strength: 500V AC/min.

*Capacitance between conductors **Capacitance between conductor and shield.

MS202

- Ideal for analog audio internal rack wiring.
- Composite conductors with 1 of 0.18 mm and 30 of 0.08 mm strands.
- Drain wire included.

MS203

- Ideal for internal rack wiring.
- Drain wire included.

Website



Two-Conductor Shielded Multichannel Cables

■ Aluminum Foil Shield

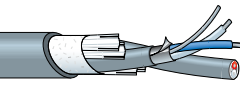
Type	Model	No. of ch.	Sales units	Nom. O.D.	Weight	No. of cond.	Unit composition			Electrical characteristics			
							Cross sec. area (AWG) and cond. comp.	Twist pitch	Ch. O. D.	Cond. DCR	Shield DCR	Nom. cap.*	Nom. cap.**
							mm ² /(AWG) Q'ty/mm	mm	mm	Ω/100m	Ω/100m	pF/m	pF/m
 L-2E4-2AL Jacket color: GRY	L-2E4-2AL	2	100 200 500	8.6	7.6	4	0.29(23) 7/0.23TA Overall tin coated	30	3.7	6.9	—	81	144
	L-2E4-4AL	4		10.8	13.1	8							
	L-2E4-8AL	8		14.9	23.7	16							
	L-2E4-12AL	12		16.9	32.0	24							
	L-2E4-16AL	16		18.8	40.0	32							

Insulation: Cross-linked PE Jacket: PVC Dielectric strength: 500V AC/min.

*Capacitance between conductors **Capacitance between conductor and shield.

L-2E4-AL Series

- Used as cables for connecting devices with which wrapping tools can be used.
- Drain wire included in each unit.

Website



No.	Dot line markings
1	—
2	—
3	—
4	—
5	—
6	—
7	—
8	—
9	—
0	—

■ Cross-sectional View

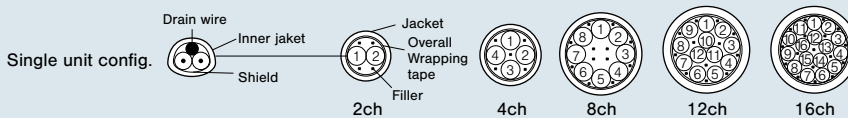

■ Channel color code: color-coded insulation and dot line markings (ch 1 to 10: red, ch 11 to 16: blue) on inner jacket (gray).

Unit no.	1	2	3	4	5	6	7	8	9	10	11	12	13	14	15	16
Insulation color	RED/ WHT	BLU/ WHT	YEL/ WHT	GRN/ WHT	BRN/ WHT	GRY/ WHT	BLU/ BLK	YEL/ BLK	GRN/ BLK	BRN/ BLK	GRY/ BLK	BLU/ ORN	YEL/ ORN	GRN/ ORN	BRN/ ORN	GRY/ ORN

Aluminum Foil Shield

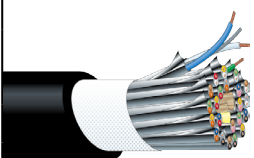
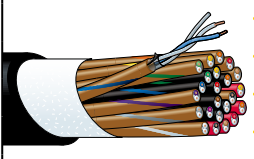
Type	Model	No. of ch.	Sales units	Nom. O.D.	Weight	No. of cond.	Unit composition			Electrical characteristics			
							Cross sec. area (AWG) and cond. comp.	Twist pitch	Ch. O. D.	Cond. DCR	Shield DCR	Nom. cap.*	Nom. cap.**
							mm ² /(AWG) Q'ty/mm	mm	mm	Ω/100m	Ω/100m	pF/m	pF/m
 M202-24AT Jacket color: BLK	M202-2AT	2	100 200 500	6.5	4.8	4	0.18(25) 16/0.12A	30	—	10.5	—	75	135
	M202-4AT	4		8.1	9.0	8							
	M202-8AT	8		11.1	16	16							
	M202-12AT	12		12.5	18	24							
	M202-16AT	16		13.8	24	32							
	M202-24AT	24		16.8	32	48							
	M202-32AT	32		18.6	40	64							
 MR202-24AT Jacket color: BLK	MR202-2AT	2	100 200 500	6.7	4.5	4	0.18(25) 7/0.18A	25	2.7	10.7	—	76	142
	MR202-4AT	4		7.6	6.2	8							
	MR202-8AT	8		11.0	13.2	16							
	MR202-12AT	12		12.7	18.4	24							
	MR202-16AT	16		14.0	22.8	32							
	MR202-24AT	24		17.4	34.0	48							
	MR202-32AT	32		19.1	43.8	64							

Insulation: Cross-linked PE Jacket: PVC Dielectric strength: 500V AC/min.

*Capacitance between conductors **Capacitance between conductor and shield.

M202-AT Series

- Multichannel cable featuring light weight and slim form. At only 16kg for a 50 m length of 24 channel cable, the M202-AT achieves a 47% weight reduction over previous Canare cables.
- Each channel is individually isolated using insulated (PET) aluminum foil shield. <Fig. 1>
- Contains the highly pull-resistant Kevlar cable filler.
- Drain wire included.

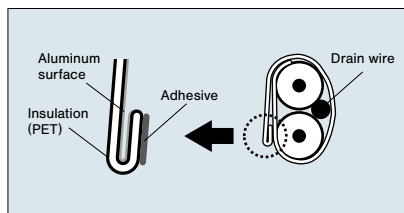
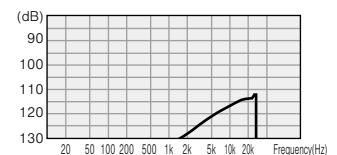

Fig. 1 Aluminum Foil Shield



Crosstalk Characteristics for M202-24AT (100m)

Note:

This series does not have inner jacket, so it cannot be used for fantails.

Website



■ Cross-sectional View

Single unit config. Drain wire, Jacket, Wrapping tape, Aluminum foil shield, Filler, Kevlar

2ch 4ch 8ch 12ch 16ch 24ch 32ch

■ Channel color code:

Unit no.	1	2	3	4	5	6	7	8	9	10	11	12	13	14	15	16	17	18	19	20	21	22	23	24	25	26	27	28	29	30	31	32
Insulation color	RED/WHT	BLU/WHT	YEL/WHT	GRN/WHT	BRN/WHT	GRY/BLK	BLU/BLK	YEL/BLK	GRN/BLK	BRN/BLK	GRY/ORN	BLU/ORN	YEL/ORN	GRN/ORN	BRN/ORN	GRY/PNK	BLU/PNK	YEL/PNK	GRN/PNK	BRN/PNK	GRY/RED	BLU/RED	YEL/RED	GRN/RED	BRN/RED	GRY/BLU	BLU/BLU	YEL/BLU	GRN/BLU	BRN/YEL	GRY/YEL	

MR202-AT Series

Our bestselling two-conductor multichannel cable featuring AWG 25 stranded conductor, 100% shielding by aluminum foil, and drain wire.

- Studio interconnect, portable snake system
- Each channel identified per resistor color-coding
- Aluminum foil shield and drain wire for easy terminate

Note:

Not appropriate for heavy-duty applications.

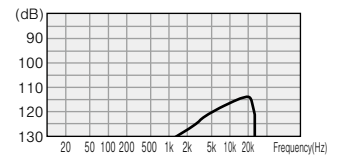

Crosstalk Characteristics for MR202-24AT (100m)

■ Cross-sectional View

Single unit config. Drain wire, Inner jacket, Jacket, Overall Wrapping tape, Aluminum foil shield, Filler

2ch 4ch 8ch 12ch 16ch 24ch 32ch

■ Channel color code: Inner jacket color coding and spiral markings.* Insulation inside units: one is clear and the other bears the same color as the spiral markings.

Unit no.	1	2	3	4	5	6	7	8	9	10	11	12	13	14	15	16	17	18	19	20	21	22	23	24	25	26	27	28	29	30	31	32
Insulation color	BRN	RED	ORN	YEL	GRN	BLU	PPL	GRY	WHT	BLK	BRN	RED	ORN	YEL	GRN	BLU	PPL	GRY	WHT	BLK	BRN	RED	ORN	YEL	GRN	BLU	PPL	GRY	WHT	BLK	BRN	RED
Spiral markings	BRN	RED	ORN	YEL	GRN	BLU	PPL	GRY	WHT	BLK	-	RED	ORN	YEL	GRN	BLU	PPL	GRY	WHT	BLK	BRN	-	ORN	YEL	GRN	BLU	PPL	GRY	WHT	BLK	BRN	RED
Inner jacket color	BLK										BRN										RED						ORN					

■ Spiral Shield

Type	Model	No. of ch.	Sales units	Nom. O.D.	Weight	No. of cond.	Unit composition				Electrical characteristics			
							Cross sec. area (AWG) and cond. comp.	Twist pitch	Shield coverage	Ch. O. D.	Cond. DCR	Shield DCR	Nom. cap.*	Nom. cap.**
							mm ² /(AWG) Q'ty/mm	mm	%	mm	Ω/100m	Ω/100m	pF/m	pF/m
 MS202-8P Jacket color: BLK	MS202-2P	2	100 200 500	7.1	5.9	4	0.18 (25) 1/0.18TA + 30/0.08TA	25	91% (spiral)	2.8	11.4	3.3	74	145
	MS202-4P	4		8.2	9.2	8								
	MS202-8P	8		10.9	16.0	16								
	MS202-12P	12		13.6	24.2	24								

Insulation : Cross-linked PE Jacket : PVC Dielectric strength : 500V AC/min.

*Capacitance between conductors **Capacitance between conductor and shield.

MS202-P Series

- Multichannel cable for analog audio.
- Composite conductors with 1 of 0.18 mm and 30 of 0.08 mm strands.
- Easy-to-use color-coded units and spiral shield.
- Drain wire included in each unit.

Website



■ Cross-sectional View

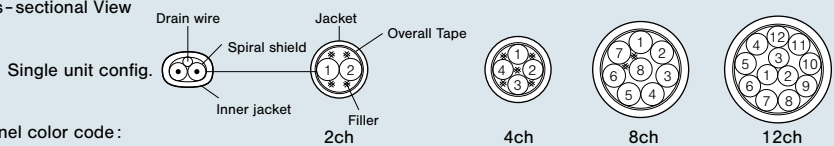

■ Channel color code :

Unit no.	1	2	3	4	5	6	7	8	9	10	11	12
Insulation color	BRN	RED	ORN	YEL	GRN	BLU	PPL	GRY	WHT	BLK	BRN	RED
Spiral markings	BRN	RED	ORN	YEL	GRN	BLU	PPL	GRY	WHT	BLK	-	RED
Inner jacket color	BLK										BRN	

■ Spiral Shield

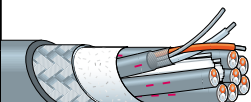
Type	Model	No. of ch.	Sales units	Nom. O.D.	Weight	No. of cond.	Unit composition				Overall shield coverage (braid)	Electrical characteristics			
							Cross sec. area (AWG) and cond. comp.	Twist pitch	Shield coverage	Ch. O. D.		Cond. DCR	Shield DCR	Nom. cap.*	Nom. cap.**
							mm ² /(AWG) Q'ty/mm	mm	%	mm		Ω/100m	Ω/100m	pF/m	pF/m
 MS203-8BS Jacket color: GRY	MS203-2BS	2	100 200 500	8.9	11	4	0.31(23) 12/0.18TA	30	91% (spiral)	3.5	79%	6.6	2.3	—	—
	MS203-4BS	4		10.3	15	8					80%				
	MS203-8BS	8		13.5	27	16									

Insulation : Cross-linked PE (orange, white) Jacket : PVC Dielectric strength : 500V AC/min.

*Capacitance between conductors **Capacitance between conductor and shield.

MS203-BS Series

- Multichannel version of MS203. (See page 51)
- Overall braided shield enables robust shielding performance.
- Drain wire included in each unit.

Website



No.	Dot line markings
1	—
2	—
3	—
4	—
5	—
6	—
7	—
8	—
9	—
0	—

■ Cross-sectional View

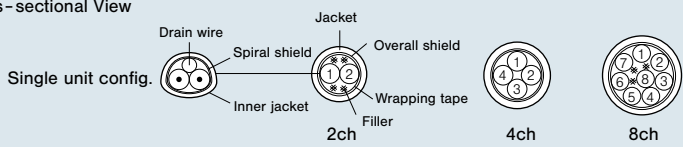

■ Unit ID : by dot line markings

AES/EBU Digital Audio Cables



Ideal for conveying digital audio signals in conformance with AES/EBU and IEC standards.

Type	No. of ch.	Model	Sales units	Nom. O.D.	Weight	Unit composition			Electrical characteristics				Charac-teristic impedance	Attenua-tion	
						Cross sec. area (AWG) and cond. comp.	Twist pitch	Shield coverage (braid)	Unit O.D.	Cond. DCR	Shield DCR	Nom. cap.*			Nom. cap.**
			m	mm	kg/100m	mm ² /(AWG) Q'ty/mm	mm	%	mm	Ω/100m	Ω/100m	pF/m	pF/m	Ω	dB/100m (3 MHz)
 Jacket color: BLU	1	DA206	100 200	7.3	7.5	0.56(20) 7/0.32A	60	95%	—	3.3	1.4	48	73	110	2.6
 Jacket color: BLU	1	DA202	100 200	5.0	3.6	0.18(25) 7/0.18A	32	95%	—	10.6	2.0	48	—	110	5.1
 Jacket color: BLU	1	DA202AT	100 200	4.0	1.6	0.18(25) 7/0.18A	38	—	—	10.6	—	45	—	110	6.7
 Jacket color: BLU	1	DA203AL	100 200	6.0	4.2	0.29(23) 7/0.23TA Overall tin coated	45	—	—	6.8	—	48	95	110	5.4
 Jacket color: BLU	2	DA202F-2P	100 200 500	7.7	6.7	0.18(25) 7/0.18TA	25	91% Spiral shield	3.0	11.3	3.0	47	95	110	5.6
	4	DA202F-4P		8.8	10										
	8	DA202F-8P		11.5	17										
 Jacket color: BLU	2	DA203-2AL	100 200 500	11.8	12.2	0.29(23) 7/0.23TA Overall tin coated	42	—	4.9	6.9	—	48	95	110	5.4
	4	DA203-4AL		13.8	18.9										
	8	DA203-8AL		19.3	33.2										
	12	DA203-12AL		21.9	44.1										

Insulation : Cross-linked PE (DA202F-P : Cross-linked foam PE) Jacket : PVC Dielectric strength : 500V AC/min. *Capacitance between conductors **Capacitance between conductor and shield.

DA206, DA202

- PE rod configuration ensures consistent 110 Ω impedance with large or small bends in cable during installation.
- DA206 ideal for digital audio paths up to 360 m*. DA202 ideal for digital audio paths up to 180 m*.
- DA202 contains a drain wire.

DA203-AL Series

- Wrapping tool can be used.
- Ideal for digital audio paths up to 170 m*.
- Drain wire included in each unit.

DA202AT

- Designed for internal cabling connections on racks.
- Ideal for digital audio paths up to 140 m*.
- Drain wire included.

DA202F Series

- Slim and lightweight.
- DA202F-8P designed to fit snugly with D-sub 25 pin connector.
- Cross-linked foam PE insulation.
- Ideal for digital audio paths up to 140 m*.
- Drain wire included in each unit.

*Condition : AES3 SR48kHz

Channel Color Coding

DA202F-P: by the insulator color & the spiral markings on the inner jacket (blue).

Unit no.	1	2	3	4	5	6	7	8
Insulator color	BRN, WHT	RED, WHT	ORG, WHT	YEL, WHT	GRN, WHT	BLU, WHT	PPL, WHT	GRY, WHT
Spiral markings	BRN	RED	ORN	YEL	GRN	-	PPL	GRY

DA203-AL: by the insulator color & the spiral markings on the inner jacket (gray).

Unit no.	1	2	3	4	5	6	7	8	9	10	11	12
Insulator color	RED, WHT	BLU, WHT	YEL, WHT	GRN, WHT	BRN, WHT	GRY, WHT	BLU, BLK	YEL, BLK	GRN, BLK	BRN, BLK	GRY, BLK	BLU, ORG
Spiral markings	RED	BLU	YEL	GRN	BRN	-	BLU, BLK	YEL, BLK	GRN, BLK	BRN, BLK	BLK	BLU, ORG

Cross-sectional View for DA202F-P & DA203-AL

Single unit config.

2ch 4ch

8ch 12ch

Speaker Cables (Single)

Website



Four-conductor configuration minimizes noise and polyethylene insulation reduces induction rate to boost frequency characteristics

4-conductor Speaker Cable

Type	Model	Pair cross-sec. mm ²	Sales units m	Nom. O.D. mm	Weight kg/100m	Composition			Electrical characteristics		
						No. of cond.	Cross sec. area (AWG)	Cond. comp.	Twist pitch	Cond. DCR	Nom. capacitance*
							mm ² /(AWG)	Q'ty/mm	mm	Ω/100m	pF/m
 Jacket colors for 4S6: GRV, BLK, RED, BLU, WHT 4S8, 4S11, 4S6G: GRV, BLK 4S8G, 4S11G: GRV	4S6	1.0	100 200 400	6.4	5.4	4	0.51(20)	20/0.18A	45	3.7	125
	4S8	2.5		8.3	9.5	4	1.27(16)	50/0.18A	70	1.5	145
	4S11	4.3		10.7	16	4	2.18(14)	41/0.26A	100	0.9	146
	4S6G	1.0		6.4	5.4	4	0.51(20)	20/0.18(OFC)	45	3.7	125
	4S8G	2.5		8.3	9.5	4	1.27(16)	50/0.18(OFC)	70	1.5	145
	4S11G	4.3		10.7	16	4	2.18(14)	41/0.26(OFC)	100	0.9	146

Insulation: polyethylene (red, translucent red, white, translucent white) Jacket: PVC Dielectric strength: 500V AC/min.

*Capacitance between conductors.

4S6, 4S8, 4S11

- High-performance PVC jacket, resistant to bending and twisting.
- 4S6 designed to fit snugly with Cannon XLR.

4S6G, 4S8G, 4S11G

- The G versions feature oxygen-free copper (OFC, JIS H3510) conductors.

4-conductor Speaker Cable for Fixed Installation

Type	Model	Pair cross-sec. mm ²	Sales units m	Nom. O.D. mm	Weight kg/100m	Composition			Electrical characteristics		
						No. of cond.	Cross sec. area (AWG)	Cond. comp.	Twist pitch	Cond. DCR	Nom. capacitance*
							mm ² /(AWG)	Q'ty/mm	mm	Ω/100m	pF/m
 Jacket colors for 4S10F, 4S12F, 4S14F, 4S18F: GRV, BLK 4S10FG, 4S12FG: GRV	4S10F	3.5	100 200 400 1000	9.6	15	4	1.75(15)	33/0.26A	100	1.1	144
	4S12F	5.6		11.6	22	4	2.81(13)	35/0.32A	120	0.7	152
	4S14F	8.0		14.0	32	4	4.02(12)	50/0.32A	120	0.5	—
	4S18F	14.2		17.5	53	4	7.08(9)	88/0.32A	150	0.3	—
	4S10FG	3.5		9.6	15	4	1.75(15)	33/0.26(OFC)	100	1.1	144
	4S12FG	5.6		11.6	22	4	2.8(13)	35/0.32(OFC)	120	0.7	152

Insulation: polyethylene (red, translucent red, white, translucent white) Jacket: PVC Dielectric strength: 500V AC/min.

*Capacitance between conductors.

4S10F, 4S12F, 4S14F, 4S18F

- Special supple jacket designed for use in building conduits.

4S10FG, 4S12FG

- The G versions feature oxygen-free copper (OFC, JIS H3510) conductors.

Multichannel Speaker Cables

Type	Model	Pair cross-sec. mm ²	Sales units m	Nom. O.D. mm	Weight kg/100m	Unit composition			Electrical characteristics		
						No. of cond.	Cross sec. area (AWG) and cond. comp.	Twist pitch	Ch. O.D.	Cond. DCR	Nom. capacitance*
							mm ² /(AWG) Q'ty/mm	mm	mm	Ω/100m	pF/m
 S410-4P Jacket color: GRV	S410-4P	2.0	100 200 500	15.0	26	16	1.0(18) 127/0.10(OFC)	50	5.1	1.9	165
	S410-6P	2.0		18.3	39	24					
	S410-8P	2.0		21.6	53	32					

Insulation: Polyethylene Jacket: PVC Dielectric strength: 500V AC/min.

*Capacitance between conductors.

S410-P Series

- Low crosstalk performance
- Ideal for use in multi-way speaker systems.
- Oxygen-free copper (OFC, JIS H3510) conductors.

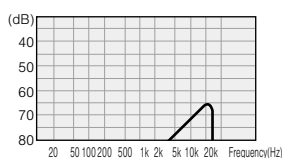
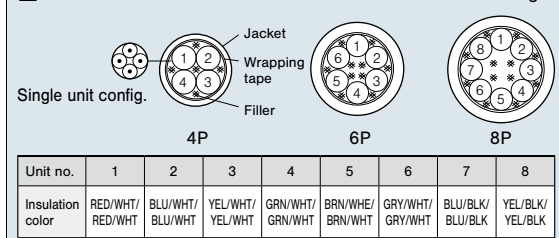

Fig. 1 Crosstalk Characteristics for S410-4P

Website



Cross-sectional View of S410-4P and Channel color coding



2-conductor Speaker Cable

Type	Model	Sales units	Nom. O.D.	Weight	Composition				Electrical characteristics	
					No. of cond.	Cross sec. area (AWG)	Cond. comp.	Twist pitch	Cond. DCR	Nom. capacitance*
		m	mm	kg/100m		mm ² /(AWG)	Q'ty/mm	mm	Ω/100m	pF/m
 2S11F Jacket colors: GRY BLK	2S7F	100 200 400	6.8	5.2	2	1.27 (16)	50/0.18A	50	1.5	56
	2S9F		8.9	8.7	2	2.18 (14)	41/0.26A	60	0.9	56
	2S11F		11.1	14	2	3.62 (12)	45/0.32A	80	0.5	55
	2S14F		13.8	21	2	5.63 (10)	70/0.32A	90	0.3	55
	2S7FG		6.8	5.2	2	1.27 (16)	50/0.18(OFC)	50	1.5	56
	2S9FG		8.9	8.7	2	2.18 (14)	41/0.26(OFC)	60	0.9	56
	2S11FG		11.1	14	2	3.62 (12)	45/0.32(OFC)	80	0.5	55
	2S14FG		13.8	21	2	5.63 (10)	70/0.32(OFC)	90	0.3	55

Insulation: polyethylene (orange, white) Jacket: PVC Dielectric strength: 500V AC/min.

*Capacitance between conductors.

2S7F, 2S9F, 2S11F, 2S14F

- Special supple jacket designed for use in building conduits.

2S7FG, 2S9FG, 2S11FG, 2S14FG

- The G versions feature oxygen-free copper (OFC, JIS H3510) conductors.

Website

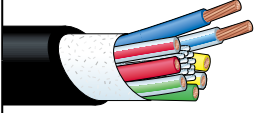

Multicore Speaker Cable

Type	Model	Sales units	Nom. O.D.	Weight	Composition			Electrical characteristics	
					No. of cond.	Cross sec. area and cond. comp.	Cond. O. D.	Cond. DCR	Nom. capacitance*
		m	mm	kg/100m		mm ² /(AWG) Q'ty/mm	mm	Ω/100m	pF/m
 8S15G Jacket color: BLK		100	14.9	33.0	8	2.49 (14) 98/0.18 (OFC)	3.26	0.7	51

Insulation: polyethylene Jacket: PVC Dielectric strength: 500V AC/min.

*Capacitance between adjacent conductors.

8S15G

- Eight-core speaker cable ideally suited for use with Neutrik speakON NL8 and a line array speaker.
- Oxygen-free copper (OFC, JIS H3510) conductors.

Website



Technical Note

Four-conductor Configuration Minimizes Noise

Speaker cable must accommodate relatively high signal levels, typically tens to hundreds of watts of RMS power. Electromagnetic interference (EMI) can radiate from these speaker lines directly into adjacent low voltage cables (i.e. microphone, video, lines, etc.). Canare solves this problem by using a 4-conductor "Star Quad" configuration in all of our 4S-series speaker cables. Because every conductor is located the same distance from center, the opposing magnetic fields are cancelled out. Attenuation of magnetic field radiation is superior when compared to a standard 2-conductor speaker wire.

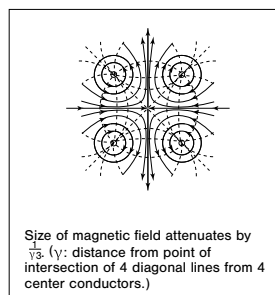

Four-conductor cable

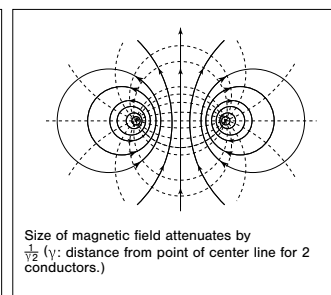

Two-conductor cable

Selecting the Right Speaker Cable

Always try to keep speaker cables as short as possible and select cable models that offer a higher damping factor; 20-50 for music (i.e. connect sound) and 10-20 for speech (i.e. sport stadiums). The greater the damping factor (DF), the better the ability to control speaker excursion to create sharp, clear quality in the low end frequency range.

$$\text{damping factor} = \frac{\text{speaker impedance}}{\text{power amp. output impedance} + \text{cable cond. resist. for total loop}}$$

As the above formula shows, a higher conductor resistance causes a lower damping factor, which prevents even top quality power amps from performing at peak optimum levels.

Speaker Cable Length obtained from the Damping Factor (reference)

Model	Cross-sec. Area	Cond. Resist.	Cond. Resist. for Total Loop	Cable Length (m)	
				DF = 20	DF = 50
4S6(G)	1.02/17 (pair)	1.85	0.037	9.5	3.0
4S8(G)	2.52/14 (pair)	0.75	0.015	23.3	7.3
4S11(G)	4.36/11 (pair)	0.45	0.009	38.9	12.2
4S10F(G)	3.50/15 (pair)	0.55	0.011	31.8	10.0
4S12F(G)	5.62/13 (pair)	0.35	0.007	50.0	15.7
4S14F(G)	8.00/12 (pair)	0.25	0.005	70.0	22.0
4S18F(G)	14.16/9 (pair)	0.15	0.003	116.7	36.7
S410-*P	2.00/18 (pair)	0.95	0.019	18.4	5.8
2S7F(G)	1.27/16	1.5	0.030	11.7	3.7
2S9F(G)	2.18/14	0.9	0.018	19.4	6.1
2S11F(G)	3.62/12	0.5	0.010	35.0	11.0
2S14F(G)	5.63/10	0.3	0.006	58.3	18.3
8S15G	2.49/14	0.7	0.014	25.0	7.9

Conditions: Speaker impedance = 8 Ω, Power amplifier output impedance = 0.05 Ω

Technical Trend

IP Connectivity Products

Fiber-Optic Systems

Connectors

Cables

Panels & Patchbays

Multichannel Systems

Cable Assemblies

Cables

OFC Line, A/V Composite Cables

OFC Line Cables

Type	Model	Sales units	Nom. O.D.	Weight	Inner cond.		Insulation	Outer conductors	Electrical characteristics		
					Cross sec. area (AWG) and cond. comp.	Nom. O.D.			Nom. O.D.	Shield construction and coverage	Chan. DCR
					m	mm	kg/100m	mm ² /(AWG) Q'ty/mm	mm	mm	mm/ends/carriers
 GS-6 Jacket colors for GS-4: BLK GS-6: BLK RED ORN YEL GRN BLU	GS-4	200	4.0	2.7	0.39(22) 50/0.1(OFC)	0.82	1.82	Carbon plastic shield + 0.1 (OFC)/6/16 93%	4.7	3.1	—
	GS-6	100 200	5.8	5.0	1.0(18) 127/0.1(OFC)	1.3	3.0	Carbon plastic shield + 0.1 (OFC)/8/16 92%	1.8	2.5	160

Insulation: polyethylene Jacket: PVC Dielectric strength: 500V AC/min.

*Capacitance between conductor to shield.

GS-4, GS-6

- Outer conductor of fine 0.1 mmφ OFC strands provide a highly flexible braided configuration. (See photographs A and B)



- Center conductor with 127 fine 0.1 mmφ strands (50 for GS-4) increases durability.

Note:
The GS-4 and GS-6 have a layer of carbon plastic shield underneath the braided shield (see Fig. 1) to block out noise. Shorting will result if this shield contacts the center conductor line, so special care must be taken when connecting the cable.

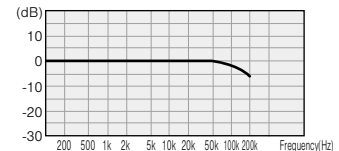
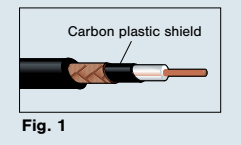
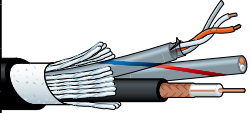

Fig. 2 Frequency Characteristics for GS-6 (100m, 100Ω → 1MΩ load)



A/V Composite Cables

Used for linking audio video equipment and as extensions for video cameras.

Type	Model	Sales units	Nom. O.D.	Weight	Unit type V: Video A: Audio C: Control line	Unit composition			Electrical characteristics	
						Cross sec. area Conductor comp.	Shield coverage	Unit O.D.	Characteristic impedance	Attenuation
						mm ² /(AWG) Q'ty/mm	%	mm	Ω	dB/100m (10 MHz)
 A2V1 Jacket color: BLK	A2V1	100 200	9.7	11	V Video 3C-2V × 1	0.20(25) 1/0.5A	97% (braid)	4.4	75	4.1
	A2V2-L		V Video 3C-2V × 2	0.20(25) 1/0.5A	97% (braid)	4.4	75	4.1		
			A Audio L-2B2AT × 2	Refer to L-2B2AT	Aluminum foil shield	3.2	—	—		
	A2V1B		V Video 3C-2VS × 1	0.18(25) 7/0.18A	97% (braid)	4.4	75	4.5		
			A Audio 4E3 Unit × 2	0.08(28) 7/0.12A	93% (braid)	3.4	—	—		
	A2V2B		V Video 3C-2VS × 2	0.18(25) 7/0.18A	97% (braid)	4.4	75	4.5		
A Audio 4E3 Unit × 2		0.08(28) 7/0.12A	93% (braid)	3.4	—	—				
A3V2-FB	V Video 3CFB Unit × 2	0.33(22) 1/0.65A	91% (braid) + Aluminum foil	4.4	75	3.7				
	A Audio L-2B2AT × 3	Refer to L-2B2AT	Aluminum foil shield	3.2	—	—				

Jacket: PVC Dielectric strength: 500V AC/min.

A2V1, A2V2-L

- Designed for fixed installation.

A2V1B, A2V2B

- Ideal for locations requiring cable bending.



A3V2-FB

- 3 balanced audio channels and 2 video coax channels for ENG, EFP, or OB applications.

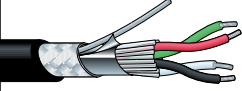

DMX Cables

Designed for DMX 512: commonly used to stage lighting control.

Type	Model	Sales units	Nom. O.D.	Weight	No. of cond.	Conductors		Shield		Cond. DCR	Characteristic impedance
						Cross sec. area (AWG) and cond. comp.	Twist pitch	Foil	Braid comp. (coverage)		
						mm ² /(AWG) Q'ty/mm	mm		mm/ends/carries		
 Jacket colors: BLK GRY WHT	DMX203-2P	100 200 500	7.9	7.9	4 (2 pair)	0.35(22) 44/0.10TA	25	AL	0.10TA/10/24 (94%)	5.9	110
 Jacket color: BLK WHT	DMX203	100 200	6.0	5.0	2 (1 pair)	0.35 (22) 44/0.10TA	45	AL	0.10TA/10/24 (94%)	5.8	110
 Jacket color: BLK WHT	DMX403	100 200	6.5	6.2	4 (quad)	0.35 (22) 44/0.10TA	50	AL	0.10TA/10/24 (94%)	5.8	110

Insulation: Cross-linked PE Jacket: Frame retardant PVC Dielectric strength: 500V AC/min.

DMX203-2P

- Standard DMX cable
- PE filler rods ensure consistent 110Ω impedance

DMX203

- Single-pair cable suitable for RDM (Remote Device Management) bidirectional communication.
- PE filler rods ensure consistent 110Ω impedance





DMX403

- Slim profile 4-conductor cable
- Can be easily inserted into Neutrik NC5 connector.
- More flexible than DMX203-2P

Website



RS422 Cables

Type	Cross-section view	Model	Sales units	Nom. O.D.	Weight	Unit type	Unit composition			Overall Shield coverage	Conductor resistance	Characteristic impedance	
							Cross sec. area (AWG) and cond. comp.	Shield coverage	Unit O.D.				
							mm ² /(AWG) Q'ty/mm	%	mm				
 Jacket color: BLK		A2C3	100 200 500	6.5	5.5	A	Digital lines two conductor shielded × 2	0.09(28) 7/0.127TA	90% Spiral shield	2.5	—	25.3	110
						C	Control lines 0.2mm ² × 3	0.22(24) 11/0.16TA	—	1.24			
 Jacket color: BLK		A2C3-SS	100 200 500	7.0	7.2	A	Digital lines two conductor shielded × 2	0.09(28) 7/0.127TA	90% Spiral shield	2.5	91% Spiral shield	25.3	110
						C	Control lines 0.2mm ² × 3	0.22(24) 11/0.16TA	—	1.24			

Insulation: Cross-linked foam PE Jacket: Frame retardant PVC Dielectric strength: 500V AC/min.

A2C3

- Short distance version of the RS422 class cables.
- Irradiated foam core PE used for the insulation in the digital signal unit.

A2C3-SS

- Created by adding an overall spiral shield to the A2C3 to heighten shielding performance.

Website



Technical Trend

IP Connectivity Products

Fiber-Optic Systems

Connectors

Cables

Panels & Patchbays

Multichannel Systems

Cable Assemblies







Ethernet Cables

Website



Experience unrivaled quality and stability with Canare ethernet cables. Engineered for AV over IP, our cables ensure professional connectivity for all your IP applications, whether you're on live productions, broadcast IP cabling, or any networking installations.

Mobile PoE PoE+ PoE++

Type	Model	Shield type	Sales units	Nom. O.D.	Weight	Conductors			Insertion loss		
						Cross sec. area & composition	DCR	Impedance	100 MHz	250 MHz	500 MHz
									mm ² /(AWG) Q'ty/mm	Ω/100m	Ω
 Jacket color: BLK	RJC6A-4P-SFM 	Overall AL foil and braid (SF/UTP)	100 200	8.6	8.9	0.26 (23) 1/0.57A	8.2	100	19.1	31.1	45.3
 Jacket color: BLK	RJC5E-4P-WJ 	N/A (U/UTP)	100 200	7.4	5.4	0.22 (24) 1/0.53A	8.8	100	22.0	—	—
 Jacket color: BLK	RJC5ES-4P-BS 	Overall braid (S/UTP)	100 200	6.7	6.1	0.22 (24) 7/0.20A	9.5	100	44.0	—	—

Insulation: polyethylene Jacket: PVC Dielectric strength: 700V AC/min

RJC6A-4P-SFM

- Flexible and rugged SF/UTP Cat6A cable
- 10GbE 10GBASE-T network
- Maximum distance to 100 meters
- Aluminum foil + braided shielding

RJC5E-4P-WJ

- Durable U/UTP Cat5e cable
- 1GbE 1000BASE-T network
- Maximum distance to 100 meters
- Double PVC jacket

RJC5ES-4P-BS

- Flexible S/UTP Cat5e cable
- 1GbE 1000BASE-T network
- Maximum distance to 50 meters
- Stranded conductors
- Braided shielding

Technical Note

Ethernet Cable Guide

Growing market demand of higher data rates, ethernet cables are adding several different types. The following is a quote from ISO/IEC standard for LAN cables.

Screened Twisted Pair (ScTP) Cables

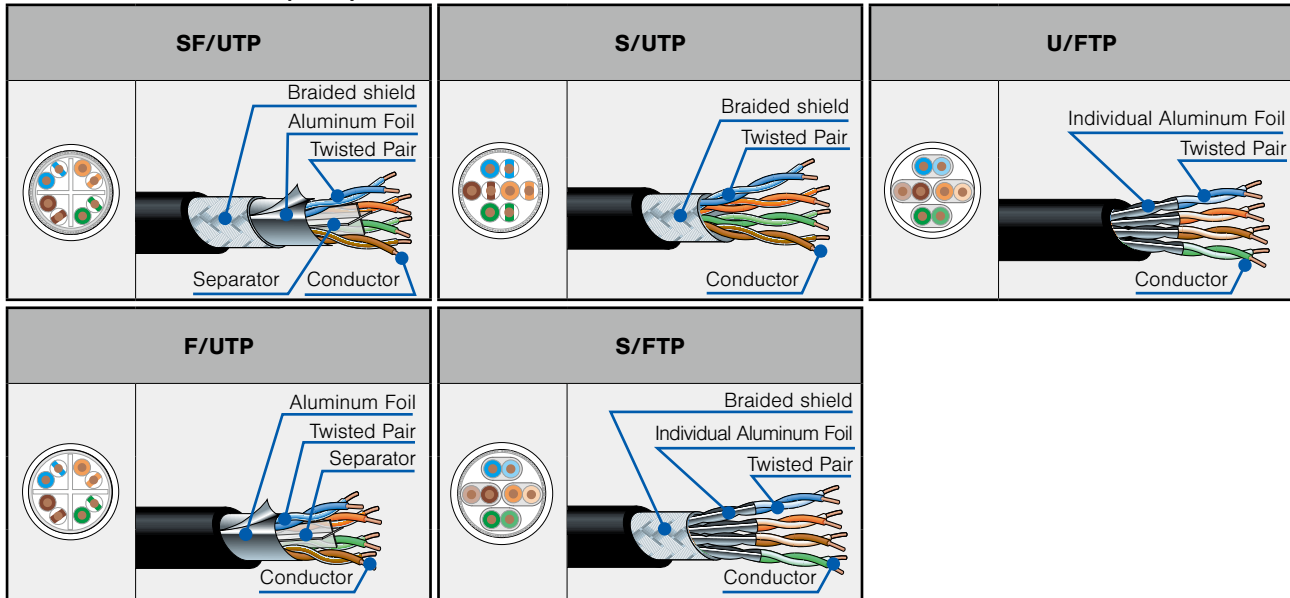

Unscreened Twisted Pair (UTP) cable

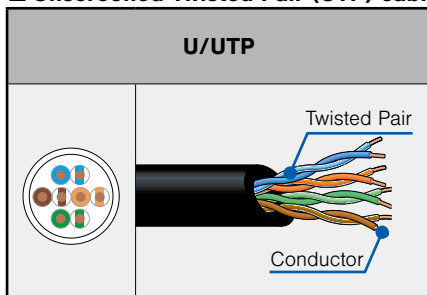













ISO/IEC 11801 (JIS X 5150)

Overall Construction		Pair or Quad	
U	Unscreened	TP	Twisted Pair
F	Foil Screened	TQ	Twisted Quad
S	Braid Screened	Element	
SF	Braid & Foil Screened	U	Unscreened
		F	Foil Screened

Note: "Screen" in the standard, Canare refers to "Shield" and "Sheath" refers to "Jacket".

General PoE PoE+ PoE++

Type	Model	Shield type	Sales units	Nom. O.D.	Weight	Conductors		Impedance	Insertion loss		
						Cross sec. area & composition	DCR		100 MHz	250 MHz	500 MHz
			m	mm	kg/100m	mm ² /(AWG) Q'ty/mm	Ω/100m	Ω	dB/100m	dB/100m	dB/100m
 Jacket colors: BLK WHT	RJC6A-F4PH  	Individual aluminum foil (U/FTP)	200	7.6	5.5	0.27(23) 1/0.59A	9.4	100	19.1	31.1	45.3
 Jacket colors: BLK	RJC6A-4P-FA   	Overall aluminum foil (F/UTP)	100 200	7.4	5.3	0.24 (23) 1/0.55A	9.4	100	19.1	31.1	45.3
 Jacket colors: BLK LB	RJC6-4P-F 	Overall aluminum foil (F/UTP)	100 200	7.0	5.0	0.23 (24) 1/0.54A	9.4	100	19.8	32.8	—
 Jacket color: BLK	RJC6-4P+ 	N/A (U/UTP)	305	6.0	3.8	0.24 (23) 1/0.55A	9.4	100	19.8	32.8	—
 Jacket color: LB	RJC5E-4P+ 	N/A (U/UTP)	305	5.0	3.0	0.20 (24) 1/0.50A	9.4	100	22.0	—	—

Insulation: polyethylene Jacket: PVC Dielectric strength: 700V AC/min.

RJC6A-F4PH

- HDBaseT3.0 Premium certified
- U/FTP Cat6A cable
- 10GbE 10GBASE-T network
- Maximum distance to 100 meters

RJC6A-4P-FA

- HDBaseT certified
- F/UTP Cat6A cable
- 10GbE 10GBASE-T network
- Maximum distance to 100 meters

RJC6-4P-F

- High quality F/UTP Cat6 cable
- 1GbE 1000BASE-T network
- Maximum distance to 100 meters

RJC6-4P+, RJC5E-4P+

- High quality U/UTP cable
- Budget friendly solution
- 305m (1000ft) in pull box
- UL rated

RJ45 Modular Plug

IDC Style Tool Less PoE PoE+ PoE++

Model	Suitable Cable	Standards
RJSP-6AFT	RJC6A-F4PH (Other suitable LAN cables specified below.)	ANSI/TIA-568-C.2 Cat6A, ISO 11801, ANSI/TIA-1096-A, IEC 60603-7

*Standard package (1 pc)

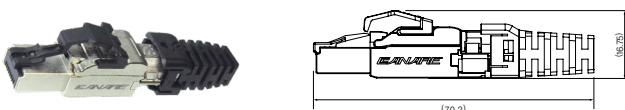

- Field termination ready
- Removable latch button reduces height by 25%
- IDC (Insulation Displacement Connection): Terminals cut into the wire for a secure, tool-free setup.

*Acceptable cables: O.D. 6.0 to 7.7mm, Insulator 0.8 to 1.47mm, 26AWG to 23AWG (Stranded / Solid)



RJSP-6AFT

Accessory

Model	Description
RJSP-FTLB	Replacement Latch Button for RJSP-6AFT, Black
TC-RJ1 	Dedicated crimping tool for RJSP-6A
RJP-PC 	Cable protection caps; compatible with O.D. 6.0-7.6 mm

IPC Style PoE PoE+ PoE++

Model	Suitable Cable	Standards	Tool
RJSP-6A 	RJC6A-4P-FA	ANSI/TIA-568-C.2 Cat6A, ISO 11801, ANSI/TIA-1096-A, IEC 60603-7	TC-RJ1

*Standard package (50pc)

- Cost-effective alternative to the RJSP-6AFT
- Requires dedicated assembly tool (TC-RJ1)
- Superior Shielding: Unique internal sled for noise resistance
- IPC (Insulation Piercing Connection): Points pierce the insulation, optimized for compact, crimp-style plugs.



RJSP-6A



RJSP-FTLB

TC-RJ1

RJP-PC

Simplified Assembly Guide *See "Instructions" for details.

Step1

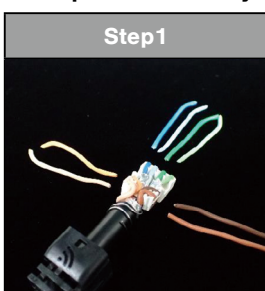

Step2



Step3

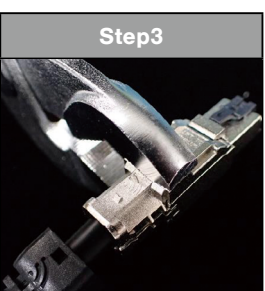

Step4

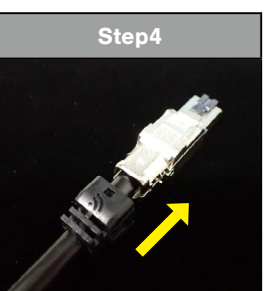

Instructions



75Ω Coaxial Cables

Website



Analog to digital. HD to UHD. Canare 75Ω coaxial cable series expands the range of choices for any kind of video formats.

■ Ultra Coax **12G-SDI**

Type	Model	Sales units	Nom. O.D.	Weight	Inner cond.		Insulation	Outer conductors		Inner cond. resist.	Outer cond. resist.	Static capacity	Characteristic impedance	Attenuation	NVP
					Comp.	O.D.		O.D.	Foil						
		m	mm	kg/100m	(AWG) Q'ty/mm	mm	mm		mm/ends/carriers	Ω/km	Ω/km	pF/m	Ω	dB/100m (6 GHz)	%
	L-3.3CUHD	100 200	5.5	4.1	(21) 1/0.75A	0.75	3.3	Cu	0.12TA/8/16 (92%)	41.4	14.9	55	75	68.5	82
	L-5.5CUHD	100 200 500 1000	7.7	7.1	(16) 1/1.35A	1.35	5.55	Cu	0.12TA/8/24 (91%)	12.8	10.3	52	75	39.5	86
	L-8CUHD	100 200 500 1000	11.1	14.1	(13) 1/2.00A	2.00	8.26	Cu	0.16TA/8/24 (90%)	5.8	6.3	52	75	28.5	86

Jacket colors: **BLK** and others

Jacket: PVC Dielectric strength: 1000V AC/min.

L-CUHD Series

- Specially designed for 12G-SDI
- The max. transmission distance of 4K UHD over L-5.5CUHD single link able to reach 100 m or longer*.
*Depending on receiving equipment.
- As handy as conventional coaxial cables.
- Copper foil and high-density tinned copper braided shielding.
- Highly-foamed multi-layer PE insulation

Note 1: Designed for fixed installation, please avoid repeated bending or external pressure.
Note 2: Cable strippers (TS100 series) cannot be used for L-5.5CUHD and L-8CUHD.

Website



■ Super Coax

Type	Model	Sales units	Nom. O.D.	Weight	Inner cond.		Insulation	Outer conductors		Inner cond. resist.	Outer cond. resist.	Static capacity	Characteristic impedance	Attenuation	NVP
					Comp.	O.D.		O.D.	Foil						
		m	mm	kg/100m	(AWG) Q'ty/mm	mm	mm		mm/ends/carriers	Ω/km	Ω/km	pF/m	Ω	dB/100m (1.5 GHz)	%
	12G-SDI L-2.5CHD	100 200	4.2	2.6	(23) 1/0.59A	0.59	2.59	AL	0.12TA/7/16 (95%)	66.9	16.9	55	75	91.7 (6 GHz)	82
	L-4CHD		6.1	5.2	(20) 1/0.82A	0.82	3.68	AL	0.14TA/8/16 (95%)	36.4	11.4	53	75	30.6	82
	12G-SDI L-4.5CHD		7.0	6.2	(18) 1/1.02A	1.02	4.58	AL	0.14TA/6/24 (91%)	23.3	9.9	55	75	53.6 (6 GHz)	81
	L-5CHD		7.7	7.4	(17) 1/1.20A	1.20	4.9	AL	0.14TA/7/24 (93%)	16.1	8.2	53	75	22.5	85
	L-6CHD		8.9	9.0	(16) 1/1.40A	1.40	6.1	AL	0.14TA/8/24 (92%)	11.8	7.7	53	75	19.0	83
	L-7CHD		10.2	13.0	(14) 1/1.80A	1.80	7.3	AL	0.16TA/8/24 (92%)	7.1	6.1	53	75	15.9	84
	L-8CHD		11.1	13.5	(12) 1/2.00A	2.00	8.2	AL	0.16TA/8/24 (89%)	5.8	6.3	53	75	14.1	84
	L-2.5CHLT	100 200	4.2	1.8	(23) 1/0.59A	0.59	2.59	AL	0.14TCCA/6/16 (95%)	66.9	21.5	53	75	43.1	82

Jacket colors: **BLK** and others

Jacket: PVC Dielectric strength: 1000V AC/min.

L-CHD Series

- Best suited to 3G-SDI/HD-SDI transmission.
- Highly-foamed PE insulation allows further improvement in the attenuation characteristics.
- Multi-layer insulation in which to each layer is given a different foaming ratio is used to increase strength.
- High-density tinned copper braided shield with aluminum foil brings excellent shielding.
- Solid conductor

L-2.5CHLT





- Ideal for an O.B. van installation.
- Tinned copper-clad aluminum (CCA) braided shield brings an advantage in weight-saving.
- 30% lighter than L-2.5CHD, yet the same attenuation.
- Space-saving slim design: O.D. 4.2 mm
- High-density braided shield with aluminum foil
- Highly-foamed PE insulation
- Solid conductor

L-2.5CHD and L-4.5CHD **12G-SDI**

- Sweep test up to 12GHz
- 12G-SDI solution with Canare Micro BNC

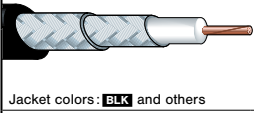
Note 1: Designed for fixed installation, please avoid repeated bending or external pressure.
Note 2: L-2.5CHLT has less connection strength with the connector BCP-B25HD compared with L-2.5CHD.
Note 3: Availability for Cable Stripper TS100 Series:
OK: L-2.5CHD and L-2.5CHLT, N/A: others

Mobile Coax

Type	Model	Sales units	Nom. O.D.	Weight	Inner cond.		Insulation	Outer conductors		Inner cond. resist.	Outer cond. resist.	Static capacity	Characteristic impedance	Attenuation	NVP
					Comp.	O.D.		Foil	Braid comp. (coverage)						
					m	mm	kg/100m			(AWG) Q'ty/mm	mm	mm	mm/ends/carriers	Ω/100m	Ω/100m
	L-3.3CUHWS <small>12G-SDI</small>	100 200	5.8	4.8	(22) 7/0.26A	0.78	3.30	AL	0.10TA/6/24 (92%) 0.10TA/7/24 (92%)	5.0	0.9	57	75	98.7 (6 GHz)	80
	L-5.5CUHWS <small>12G-SDI</small>	100 200 300	8.1	8.7	(16) 7/ Compact strand	1.30	5.56		0.10TA/9/24 (93%) 0.10TA/9/24 (90%)	1.4	0.8	54	75	57.0 (6 GHz)	82.5
	L-2.5CHWS	100 200	4.2	3.2	(24) 7/0.20A	0.6	2.6	AL	0.10TA/8/16 (95%) 0.10TA/9/16 (94%)	8.5	1.0	53	75	54.7	81
	L-4.5CHWS	100 200	7.2	6.6	(20) 7/0.34A	1.02	4.57		0.10A/8/24 (93%) 0.10A/9/24 (95%)	3.3	0.8	53	75	33.3	79.5
	L-3CFW	100 200	5.8	5.1	(22) 1/0.65A	0.65	3.1	AL	0.12A/5/24 (94%) 0.12A/6/24 (94%)	5.5	0.7	55	75	49.4	79
	L-5CFW	1000	7.7	8.1	(18) 1/1.05A	1.05	5.0		0.12A/7/24 (93%) 0.12A/9/24 (96%)	2.1	0.5	55	75	28.4	79

Jacket: PVC Dielectric strength: 1000V AC/min.

L-CUHWS Series 12G-SDI

- Specially designed for 12G-SDI mobile applications
- Flexible and low loss structure
- Highly-foamed PE insulation
- High-density double braided shield

Note: L-CUHWS series is specially designed as a cable for mobile use. Refer to "Typical Transmission Distance as per SMPTE Standard" on page66 for the length of the cable to be used.

L-CHWS Series

- Designed for mobile applications
- Flexible stranded center conductor
- Highly-foamed PE insulation
- High-density double braided shield

Note: Cable strippers (TS100 series) cannot be used for Mobile Coax.

L-CFW Series

- Designed for mobile applications
- Solid center conductor
- Foamed PE insulation
- High-density double braided shield

Website

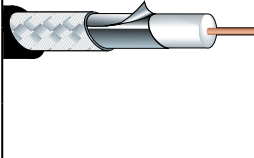

Low Loss Coax

Type	Model	Sales units	Nom. O.D.	Weight	Inner cond.		Insulation	Outer conductors		Inner cond. resist.	Outer cond. resist.	Static capacity	Characteristic impedance	Attenuation	NVP
					Comp.	O.D.		Foil	Braid comp. (coverage)						
					m	mm	kg/100m			(AWG) Q'ty/mm	mm	mm	mm/ends/carriers	Ω/100m	Ω/100m
	L-2.5CFB	100 200	4.0	2.4	(25) 1/0.50A	0.50	2.4	AL	0.12TA/6/16 (92%)	9.3	2.0	55	75	37.0	79
	L-3CFB		5.5	4.0	(22) 1/0.65A	0.65	3.1		0.14TA/6/16 (91%)	5.5	1.6	55	75	29.1	79
	L-4CFB		6.1	4.9	(20) 1/0.80A	0.80	3.7		0.14TA/8/16 (93%)	3.6	1.1	55	75	23.6	79
	L-5CFB		7.7	7.3	(18) 1/1.05A	1.05	5.0		0.14TA/7/24 (93%)	2.1	0.8	55	75	17.7	79
	L-7CFB		10.2	13.0	(15) 1/1.50A	1.50	7.3		0.18TA/8/24 (95%)	1.0	0.5	55	75	13.4	79

Jacket: PVC Dielectric strength: 1000V AC/min.

Note: Designed for fixed installation, please avoid repeated bending or external pressure.

L-CFB Series

- Suited to HD video signals
- High-density tinned copper braided shield with aluminum foil
- Solid center conductor
- Foamed PE insulation

Website



Technical Trend

IP Connectivity Products

Fiber-Optic Systems

Connectors



Cables

Panels & Patchbays

Multichannel Systems

Cable Assemblies

Standard Coax (Solid PE Insulation)

Type	Model	Sales units	Nom. O.D.	Weight	Inner cond.		Insulation	Outer conductors		Inner cond. resist.	Outer cond. resist.	Static capacity	Characteristic impedance	Attenuation	NVP
					Comp.	O.D.		O.D.	Braid composition (coverage)						
					m	mm	kg/100m	(AWG) Q'ty/mm	mm	mm	mm	mm/ends/carriers	Ω/100m	Ω/100m	pF/m
 L-3C2VS Jacket colors: BLK and others	L-1.5C2VS	200	2.9	1.3	(31) 7/0.09A	0.27	1.6		0.10A/5/16 (94%)	41.9	3.3	69	75	8.7	66
	L-3C2VS	100 200	5.5	4.5	(25) 7/0.18A	0.54	3.1		0.12A/7/16 (94%)	10.5	1.9	67	75	4.5	66
	LV-61S	153	6.1	5.0	(24) 7/0.20A	0.60	3.6		0.12A/6/24 (95%)	8.5	1.3	67	75	3.8	66
	L-5C2VS	100 200	7.4	6.8	(22) 7/0.26A	0.78	4.8		0.12A/7/24 (93%)	5.0	1.2	67	75	2.9	66
 L-3C2V Jacket colors: BLK and others	L-2.5C2V	100 200	4.0	2.4	(26) 1/0.40A	0.40	2.4		0.12TA/6/16 (94%)	19.2	2.1	69	75	5.2	66
	L-3C2V		5.4	4.3	(25) 1/0.50A	0.50	3.1		0.14TA/5/24 (97%)	9.3	1.2	67	75	4.1	66
	L-5C2V		7.4	7.2	(20) 1/0.80A	0.80	4.9		0.14TA/7/24 (94%)	3.6	0.8	67	75	2.5	66
 L-3C2W Jacket color: BLK	L-3C2W	100 200	6.5	7.0	(25) 1/0.50A	0.50	3.1		0.14TA/5/24 (97%) 0.14TA/5/24 (93%)	9.3	0.6	67	75	4.1	66
	L-5C2W		8.3	11.0	(20) 1/0.80A	0.80	4.9		0.14TA/7/24 (94%) 0.14TA/7/24 (95%)	3.6	0.4	67	75	2.5	66
	LV-77S	153	7.7	9.0	(22) 7/0.26A	0.78	4.8		0.12A/7/24 (92%) 0.12A/8/24 (95%)	5.0	0.6	67	75	3.4	66

Jacket: PVC Dielectric strength: 1000V AC/min.

L-1.5C2VS, L-3C2VS, L-5C2VS, LV-61S

- Ideal for locations requiring cable bending.
- Flexible stranded center conductor
- High-density braided shield
- LV-61S is equivalent to RG-59B/U

L-2.5C2V, L-3C2V, L-5C2V

- Solid center conductor
- High-density tinned copper braided shield

L-3C2W, L-5C2W

- Solid center conductor
- High-density tinned copper double braided shield

LV-77S

- Ideal for locations requiring cable bending.
- Flexible stranded center conductor
- High-density double braided shield

Note: Cable strippers (TS100 series) cannot be used for L-1.5C2VS, L-3C2W, L-5C2W and LV-77S

Website



Analog HD Coax

Type	Model	Sales units	Nom. O.D.	Weight	Inner cond.		Insulation	Outer conductors		Inner cond. resist.	Outer cond. resist.	Static capacity	Characteristic impedance	Attenuation	NVP
					Comp.	O.D.		O.D.	Foil						
					m	mm	kg/100m	(AWG) Q'ty/mm	mm	mm	mm	mm	mm/ends/carriers	Ω/100m	Ω/100m
 Jacket color: BLK	L-3C-AHD	300	5.5	3.0	(21) 1/0.75A	0.75	3.3	AL	0.14AL/4/24 (84%)	4.1	3.7	55	75	2.5	82

Jacket: PVC Dielectric strength: 1000V AC/min.

L-3C-AHD

- Cost effective aluminum alloy braided shield
- Recommended for an analog high definition video surveillance system.
- Fits for AHD, HD-TVI and HD-CVI, and also for HD-SDI or EX-SDI
- Highly-foamed PE insulation for better transmission characteristics
- Packaged in REELEX pull box

Note 1: The aluminum braid cannot be soldered. BNC crimp plug for L-3C-AHD: BCP-A3AHD (see page21)
Note 2: Designed for fix installation

Nominal Attenuation

dB/100m

NTSC D1 7MHz	NTSC WD1 10MHz	AHD 1080/30p 36MHz	HD-TVI 1080/30p 48MHz	EX-SDI 1080/30p 135MHz	270 MHz	HD-SDI 750MHz	3G-SDI 1500MHz
2.0	2.5	4.9	5.7	10.1	14.3	24.2	34.7

Website



75Ω Triaxial Cables

Type	Model	Sales units	Nom. O.D.	Weight	Inner cond.		Insulation 1	Outer cond.1	Insulation 2	Outer cond.2	Electrical characteristics			Charac-teristic impedance	Attenu-ation	NVP	
					Comp.	O.D.					O.D.	Braid coverage and comp.	O.D.				Braid coverage and comp.
		m	mm	kg/100m	(AWG) Q'ty/mm	mm	mm	mm	mm	mm	mm	Ω/100m	Ω/100m	pF/m	Ω	dB/100m (10 MHz)	%
 L-5CFTX Jacket colors: BLK RED GRN	L-5CFTX	100 200	8.8	12.0	(19) 1/1.0A	1.0	4.8	0.14A/6/24 (91%)	6.4	0.16A/8/24 (95%)	2.3	—	55	75	2.2	79	
	L-4CFTX	100 200	9.1	10.5	(20) 1/0.80A	0.80	3.7	0.14A/7/16 (93%)	5.5	0.14A/7/24 (94%)	3.64	—	55	75	3.0	79	
	L-7CFTX	100 200 500	11.0	15.4	(16) 1/1.40A	1.40	6.5	0.14A/8/24 (93%)	8.7	0.14A/8/24 (88%)	1.18	—	55	75	1.7	79	



Insulation: 1: foamed PE 2: polyethylene Dielectric strength: 1000V AC/min.

- For digital or analog broadcast camera applications.
- Abrasion-resistance PVC jacket.

Website



75Ω Multichannel Coaxial Cables

Type	Model	No. of ch.	Sales units	Nom. O.D.	Weight	Unit composition						Inner cond. resist.	Outer cond. resist.	Charac-teristic impedance	Attenu-ation	NVP
						Inner cond.		Insulation	Outer conductors		Unit O.D.					
						Comp.	O.D.		O.D.	Foil						
		m	mm	kg/100m	(AWG) Q'ty/mm	mm	mm	mm	mm	mm	Ω/100m	Ω/100m	Ω	dB/100m (750 MHz)	%	
 V4- *CFB Jacket color: BLK Insulation: Foamed PE	V3-3CFB	3	100 500	11.5	14	(22) 1/0.65A	0.65	3.1	AL	0.14TA/6/16 (91%)	4.4	5.6	1.6	75	29.1	79
	V4-3CFB	4		13.0	19											
	V5-3CFB	5		14.2	23											
	V3-4CFB	3		12.9	18	(20) 1/0.80A	0.80	3.7	AL	0.14TA/8/16 (93%)	5.0	3.6	1.1	75	24.3	79
	V4-4CFB	4		14.4	23											
	V5-4CFB	5		16.1	29											
	V3-5CFB	3		17.1	29	(18) 1/1.05A	1.05	5.0	AL	0.14TA/7/24 (93%)	6.5	2.1	0.8	75	17.7	79
	V4-5CFB	4		18.8	36											
	V5-5CFB	5		21.1	46											
 V4-2.5 CHW Jacket color: BLK Insulation: Highly-foamed PE	V4-2.5CHW	4	100 500	13.0	21	(23) 1/0.59A	0.59	2.59	—	0.10TA/8/16 (95%) 0.10TA/9/16 (94%)	4.2	6.7	1.0	75	35.7	81
	V3-3CFW	3	100 500	13.0	22	(22) 1/0.65A	0.65	3.1	—	0.12A/5/24 (94%) 0.12A/6/24 (94%)	4.9	5.6	0.7	75	33.1	79
V4-3CFW	4	14.6		28												
V5-3CFW	5	16.2		34												
V3-5CFW	3	18.4		36	(18) 1/1.05A	1.05	5.0	—	0.12A/7/24 (93%) 0.12A/9/24 (96%)	7.0	2.1	0.5	75	19.4	79	
V4-5CFW	4	20.4		47												
V5-5CFW	5	22.4		58												
 V4- *C Jacket color: BLK Insulation: Solid PE	V3-1.5C	3	100 500	7.4	7.3	(31) 7/0.09A	0.27	1.55	—	0.10A/5/16 (94%)	2.6	42.3	3.3	75	—	66
	V4-1.5C	4		8.4	9.4											
	V5-1.5C	5		9.2	11											
	V3-3C	3		11.5	15	(25) 7/0.18A	0.54	3.1	—	0.14A/5/24 (97%)	4.4	10.6	1.1	75	43.2	66
	V4-3C	4		13.0	20											
	V5-3C	5		14.2	24											
	V3-5C	3		15.5	26	(22) 7/0.26A	0.78	4.8	—	0.12A/7/24 (93%)	6.0	5.1	1.2	75	29.2	66
	V4-5C	4		17.1	33											
	V5-5C	5		19.2	39											

Jacket PVC Dielectric strength: 1000V AC/min.

Note: Cable strippers (TS100 series) cannot be used for V-CHW, V-CFW, and V-1.5C.

V-CFB Series

- Low-loss multichannel coax for fixed installations.

V-CHW, V-CFW Series

- Mobile multichannel coax developed for digital video signals.

V-C Series

- Our long selling standard multichannel coax with flexible stranded center conductor.
- Ideal for component video signals.

Website

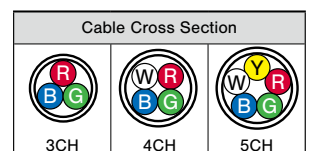

Technical Note

Many types of video coax. What're the differences and how select?

In brief, there are three of essential factors : **1** center conductor, **2** insulation, and **3** shield.
Each factor has its advantage and disadvantage as described below :

1	Center Conductor	Solid conductor	Single solid metal core, low signal loss, ideal for long-distance or high-frequency transmission.
		Stranded conductor	Multiple thin strands twisted together, offers flexibility and resistance to bending, commonly used for patch cords and mobile applications.
		Compact strand conductor	Multiple fine metal wires tightly bundled, denser than regular stranded conductors, which achieving advantages from both solid and stranded. It enhances low signal loss and flexibility, ideal for 12G-SDI mobile applications.
2	Insulation	Includes "Solid", "Foamed", and "Highly-foamed" types. Foamed and highly-foamed insulation would perform better attenuation, compared to the solid type thus they are often selected for hi-def video. However, since foamed and high-foamed insulation contain the air physically, they are weak to external pressure. You should pay attention to where and how the cables are installed.	
3	Shield	We have "Braided" and "Braided with aluminum foil" type. Braided shields include single, double, or triple layers as well as bare copper or tinned copper. Braided with aluminum foil offers perfect screening, but they are not suitable for repeated bending and mobile applications due to the foil's lack of strength. In that case, it's better to choose "Braided".	

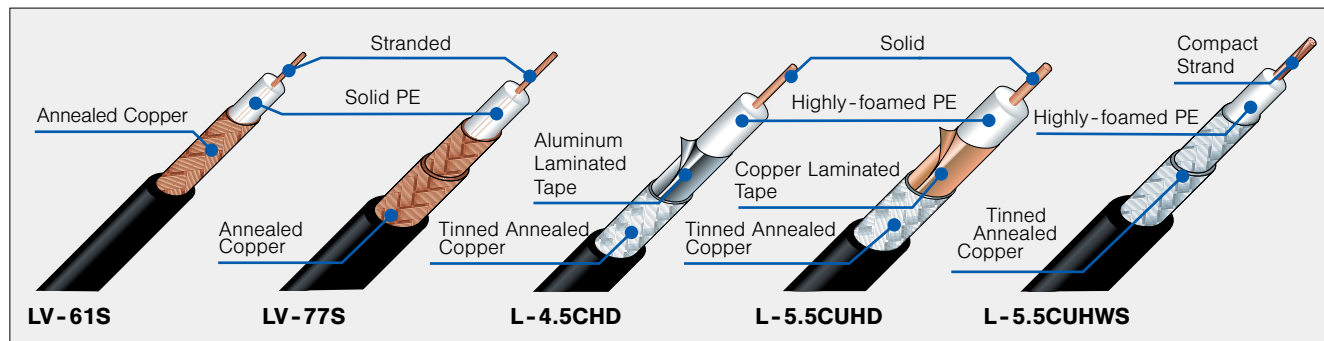

What is Propagation Delay?

Propagation delay refers to the time required for a signal to be transmitted from one end of connection to another. In the case of cable transmission, this greatly depends on the materials and construction of the actual cable, and large differences in delay can cause transmission errors if they exceed the receiver delay tolerance.

The following table shows the differences in coaxial cable propagation delay time relative to the insulation type.

Propagation Delay Caused by Coaxial Cable Insulation (reference)

Insulation	Propagation Delay
Solid PE	5.0 ns/m
Foamed PE	4.2 ns/m
Highly-Foamed PE	3.7 ns/m

Typical Transmission Distance as per SMPTE Standard

SMPTE	ST 259				ST 344	ST 292	ST 424	ST 2082-1
	SD-SDI				540 Mbps-SDI	HD-SDI	3G-SDI	12G-SDI
Video Format	NTSC	PAL	525/625 (4:3)	525/625 (16:9)	525/625 (4:3) p60	2K 1080i	2K 1080p	4K UHD
Bit Rate	143 Mb/s	177 Mb/s	270 Mb/s	360 Mb/s	540 Mb/s	1.5 Gb/s	3 Gb/s	12 Gb/s
Clock	143 MHz	177 MHz	270 MHz	360 MHz	540 MHz	1.485 GHz	2.97 GHz	11.88 GHz
Cable Loss @ 1/2 Clock	30 dB @ 72 MHz	30 dB @ 88 MHz	30 dB @ 135 MHz	30 dB @ 180 MHz	30 dB @ 270 MHz	20 dB @ 750 MHz	30 dB @ 1.5 GHz	40 dB @ 6 GHz
Model	m	m	m	m	m	m	m	m
L-2.5CFB	265	242	199	172	139	54	55	32
L-2.5CHD	314	287	237	206	168	66	69	43
L-2.5CHLT	314	287	237	206	168	66	69	43
L-3CFB	344	314	257	222	179	68	69	42
L-3.3CUHD	461	422	306	265	215	85	90	58
L-4CFB	422	314	315	272	220	84	86	52
L-4CHD	447	410	337	294	238	93	98	61
L-5CFB	563	513	420	364	294	112	114	68
L-4.5CHD	551	504	415	361	293	115	119	74
L-5CHD	614	562	464	403	327	128	133	82
L-6CHD	766	700	575	499	403	154	158	95
L-5.5CUHD	769	697	566	491	400	155	157	101
L-7CHD	902	824	678	589	476	184	188	116
L-8CHD	1034	937	769	681	545	208	212	131
L-8CUHD	1034	937	789	681	555	217	225	140
L-2.5CHWS	275	247	198	171	138	53	54	32
V4-2.5CHW	288	258	208	178	144	56	57	34
L-3CFW	319	288	230	197	158	60	60	35
L-3.3CUHWS	333	300	240	206	167	64	66	40
L-4.5CHWS	447	405	322	280	225	87	90	50
L-5CFW	535	483	384	333	267	103	105	56
L-5.5CUHWS	612	555	441	379	306	117	120	70

*The above values are distances when cable loss reaches a typical attenuation specified by SMPTE standard at 1/2 clock frequency.

*These values are not equivalent to actual transmission distances, which depends on the equalized distance of receiver.

*Please check with vendor of receiver for equalized distance and reference cable to calculate actual transmission distance.



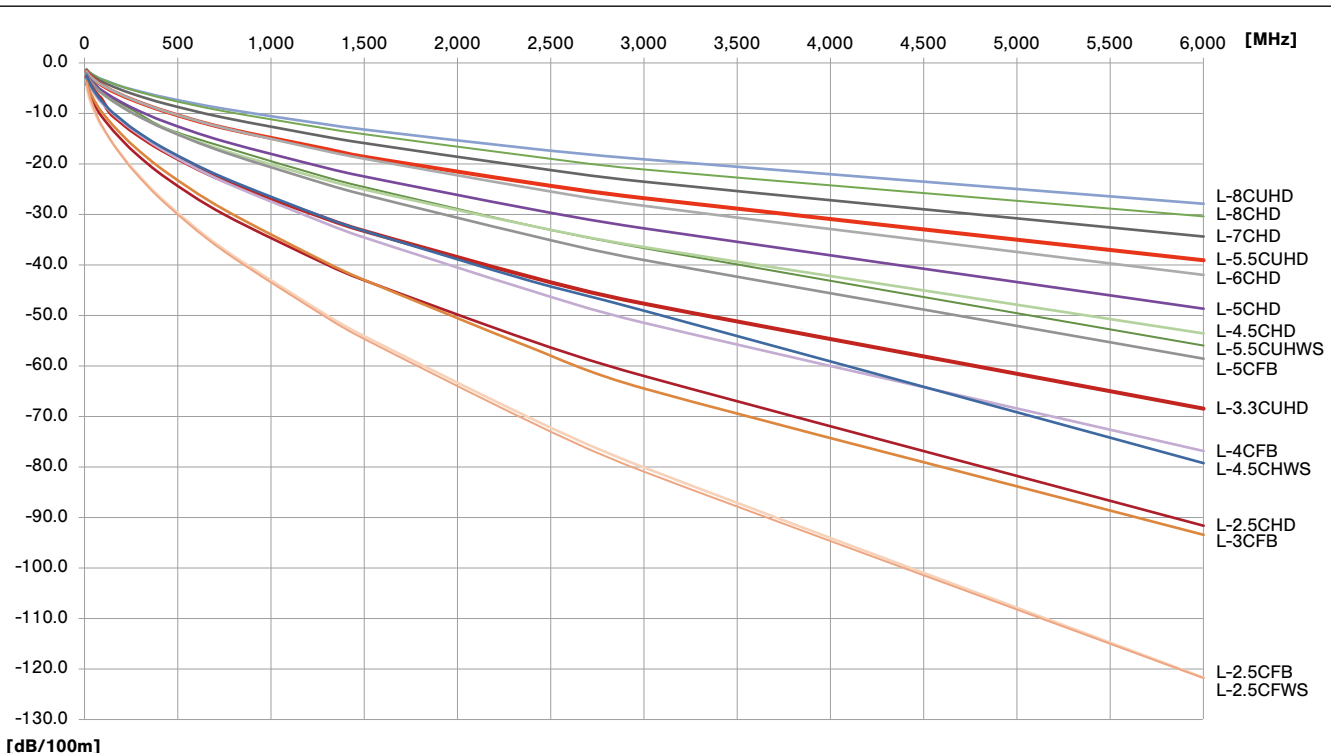

75Ω Coax Cable Nominal Attenuation

Model		Frequency												dB/100m
		10MHz	30MHz	SMPTE 259M Composite NTSC 72.0MHz	ITU-R BT.601 Composite PAL 88.0MHz	SMPTE 259M Composite 4:2:2 135MHz	SMPTE 259M Composite 4:2:2 16x9 180MHz	SMPTE 344M 540Mb/s SDI 270MHz	SMPTE 292M HD-SDI 750MHz	1.3GHz	1.5GHz	3GHz	6GHz	
75Ω	L-1.5C2VS	8.7	15.2	23.9	26.6	33.2	38.7	48.0	83.7	114.0	123.7	185.9	—	
	V*-1.5C	8.7	15.1	23.6	26.2	32.7	37.9	46.8	80.5	108.6	117.5	173.4	—	
	L-2.5CFB	4.8	7.6	11.3	12.4	15.1	17.4	21.5	37.0	50.0	54.1	80.2	121.8	
	L-2.5CHD/L-2.5CHLT	4.1	6.5	9.5	10.4	12.6	14.5	17.8	30.2	40.0	43.1	62.0	91.7	
	L-2.5CHWS	4.0	7.0	10.9	12.1	15.1	17.5	21.7	37.4	50.5	54.7	81.0	121.9	
	V4-2.5CHW	3.8	6.7	10.4	11.6	14.4	16.8	20.7	35.7	48.3	52.3	77.4	115.9	
	L-3C2V/L-3C2W	4.1	7.2	11.3	12.5	15.7	18.3	22.8	40.0	54.9	59.7	90.5	—	
	L-3C2VS/V*-3C	4.5	7.9	12.4	13.8	17.2	20.0	24.8	43.3	58.9	63.9	96.0	—	
	L-3CFB/V*-3CFB	3.7	5.9	8.7	9.5	11.7	13.5	16.7	29.1	39.6	43.0	64.5	93.5	
	L-3CFW/V*-3CFW	3.4	5.9	9.4	10.4	13.0	15.2	18.9	33.1	45.4	49.4	74.8	114.2	
	L-3.3CUHD	2.8	4.4	6.5	7.1	9.8	11.3	13.9	23.4	30.9	33.3	47.7	68.5	
	L-3.3CUHWS	3.3	5.8	9.0	10.0	12.5	14.5	17.9	30.8	41.4	44.8	66.1	98.7	
	L-4CFB	3.0	4.8	7.1	7.8	9.5	11.0	13.6	23.6	31.9	34.6	51.5	76.9	
	V*-4CFB	3.0	4.9	7.2	7.9	9.7	11.2	13.9	24.3	33.2	36.0	54.3	83.8	
	L-4CHD	2.9	4.6	6.7	7.3	8.9	10.2	12.6	21.3	28.4	30.6	44.3	65.1	
	L-4.5CHD	2.3	3.7	5.4	6.0	7.2	8.3	10.2	17.4	23.2	25.1	36.5	53.6	
	L-4.5CHWS	2.5	4.3	6.7	7.4	9.3	10.7	13.3	22.8	30.8	33.3	49.1	79.3	
	L-5C2V/L-5C2W	2.5	4.5	7.1	7.9	9.9	11.5	14.4	25.7	35.7	38.9	60.0	94.8	
	L-5C2VS/V*-5C	2.9	5.1	8.1	9.0	11.3	13.2	16.5	29.3	40.8	44.4	68.3	108.0	
	L-5CFB/V*-5CFB	2.2	3.6	5.3	5.8	7.1	8.2	10.2	17.7	24.1	26.1	39.1	58.6	
	L-5CFW/V*-5CFW	2.1	3.6	5.6	6.2	7.8	9.0	11.2	19.4	26.2	28.4	42.2	70.5	
	L-5CHD	2.1	3.3	4.9	5.3	6.5	7.4	9.1	15.6	20.8	22.5	32.8	48.7	
	L-5.5CUHD	1.5	2.5	3.9	4.3	5.3	6.1	7.5	13.3	17.1	19.0	26.8	39.5	
	L-5.5CUHWS	1.8	3.1	4.9	5.4	6.8	7.9	9.8	17.0	23.6	25.0	37.4	57.0	
	L-6CHD	1.7	2.7	3.9	4.3	5.2	6.0	7.4	12.9	17.5	19.0	28.3	42.0	
	L-7CFB	1.6	2.5	3.8	4.2	5.1	6.0	7.5	13.4	18.8	20.5	32.0	53.6	
	L-7CHD	1.4	2.3	3.3	3.6	4.4	5.1	6.3	10.9	14.7	15.9	23.5	34.4	
	L-8CHD	1.2	2.0	2.9	3.2	3.9	4.4	5.5	9.6	13.0	14.1	21.1	30.4	
	L-8CUHD	1.2	2.0	2.9	3.2	3.8	4.4	5.4	9.2	12.2	13.3	19.1	28.5	
	LV-61S	3.8	6.6	10.4	11.5	14.4	16.8	20.9	36.8	50.4	54.8	83.1	—	
LV-77S	2.9	5.2	8.1	9.0	11.3	13.1	16.3	28.6	—	—	—	—		

75Ω Low Loss Coax Cable Attenuation Chart



50Ω Coaxial Cables

Type	Model	Sales units	Nom. O.D.	Weight	Inner cond.		Insulation	Outer conductors		Inner cond. resist.	Outer cond. resist.	Static capacity	Characteristic impedance	Attenuation
					Comp.	O.D.		Foil	Braid comp. (coverage)					
					(AWG) Q'ty/mm	mm								
 L-3D2V Jacket: PVC Color: GRY	L-3D2V	100	5.3	4.5	(20) 7/0.32A	0.96	3.0	—	0.14TA/5/24 (98%)	3.3	1.2	100	50	4.5
	L-5D2V	200	7.3	7.9	(15) 1/1.40A	1.40	4.8	—	0.14TA/7/24 (95%)	1.2	0.8	100	50	2.5
 L-3D2W Jacket: PVC Color: GRY	L-3D2W	100	6.4	7.3	(20) 7/0.32A	0.96	3.0	—	0.14TA/5/24 (98%) 0.14TA/5/24 (96%)	3.3	0.6	100	50	4.5
	L-5D2W	200	8.0	11.0	(15) 1/1.40A	1.40	4.8	—	0.14TA/7/24 (95%) 0.14TA/7/24 (96%)	1.2	0.4	100	50	2.5
 Jacket: PVC Color: BLK	L-5DFB	100	7.6	8.5	(14) 1/1.80A	1.80	5.0	AL	0.14TA/6/24 (90%)	0.7	1.1	84	50	2.4
 Jacket: PE Color: BLK	L-5DFBW-PE	100	8.0	10.4	(14) 1/1.80A	1.80	5.0	AL	0.14TA/7/24 (93%) 0.14TA/8/24 (95%)	0.7	0.4	84	50	2.4

Insulation: polyethylene Dielectric strength: 1000V AC/min



L-3D2V, L-5D2V

- Tinned copper braided shield

L-3D2W, L-5D2W

- Tinned copper double braided shield

L-5DFB

- Low-loss foamed PE insulation
- Tinned copper braided shield with aluminum foil.

Note: Designed for fixed installation.

L-5DFBW-PE

- Ideal for digital microwave communication systems
- PE jacket for fixed outdoor installation
- Low-loss foamed PE insulation
- Tinned copper double braided shield with aluminum foil

Note: Designed for fixed installation.

■ 50Ω Coax Cable Nominal Attenuation

dB/100m

Model		Frequency														
		10 MHz	130 MHz	470 MHz	600 MHz	710 MHz	714 MHz	800 MHz	1240 MHz	1260 MHz	1575 MHz	1700 MHz	2000 MHz	2400 MHz	2600 MHz	6000 MHz
50Ω	L-3D2V / L-3D2W	4.5	17.3	35.4	40.7	44.9	45.1	48.2	62.6	63.2	72.5	76.0	84.1	94.4	99.3	172.9
	L-5D2V / L-5D2W	2.5	9.6	19.6	22.6	25.0	25.1	26.8	35.0	35.3	40.5	42.5	47.1	53.0	55.8	98.0
	L-5DFB / L-5DFBW-PE	2.4	6.9	13.7	15.6	17.1	17.2	18.2	23.1	23.3	26.4	27.5	30.1	33.3	34.8	56.4

Technical Trend

IP Connectivity Products

Fiber-Optic Systems

Connectors

Cables

Panels & Patchbays

Multichannel Systems

Cable Assemblies