

Snake Trunk



Junction Box



Fantail



Cable Reel Snake



System Example

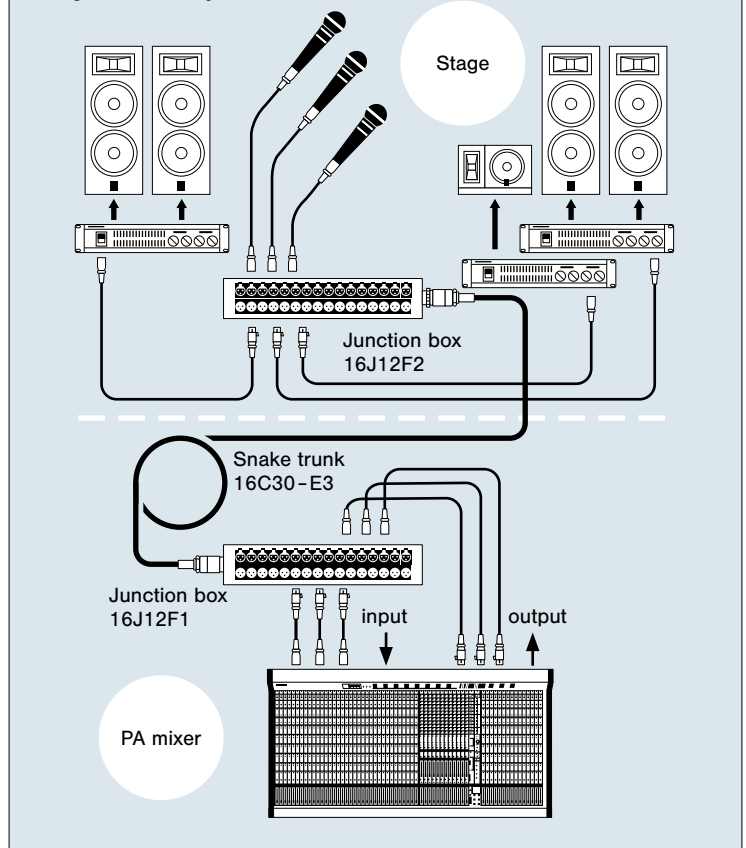







Connectors used with Canare multichannel cable system



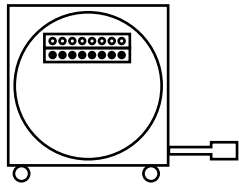
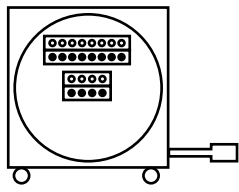
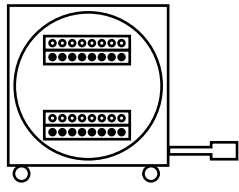
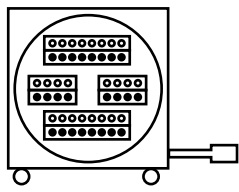

Cable mount	Panel mount	Cable mount	Panel mount
XLR3-11C (female)	XLR3-32-F77 (male)	XLR3-12C (male)	XLR3-31-F77 (female)
For multichannel cable Plug	For Junction box Receptacle	For multichannel cable Plug	For Junction box Receptacle
NK27-21C-R (female) + NK-AD1-R (barrel extension)	NK27-32S-R (male)	FK37-21C-R (female) + FK-AD2-R (barrel extension)	FK37-32S-R (male)
NK27-22C-R (male) + NK-AD1-R (barrel extension)	NK27-31S-R (female)	FK37-22C-R (male) + FK-AD2-R (barrel extension)	FK37-31S-R (female)
D/MS3106B32A-10S (female) + EB-02 (barrel extension) + D/MS3057-20A(R1) (cable clamp)	D/MS3102A32A-10P (male)	D/MS3106B36-73S (female) + EB-03 (barrel extension) + D/MS3057-24A(R1) (cable clamp)	D/MS3102A36-73P (male)

Multichannel Systems

Snake Trunks, Cable Reel Snakes

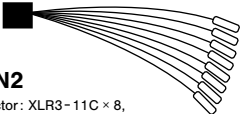
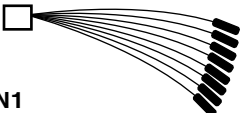
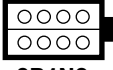
	Snake Trunks	Cable Reel Snakes																																								
8 CH	<p>L-4E3 Star quad, Braided shield</p>  <p>Connector: NK27-21C 3/4-R, NK27-22C 3/4-R Cable: L-4E3-8P (black) Rubber bushing: AN3420-12(R1) + Heat Shrink Tube</p> <table border="1"> <thead> <tr> <th>Model</th> <th>Length</th> <th>Weight</th> </tr> </thead> <tbody> <tr> <td>8C05-E3</td> <td>5m</td> <td>1.6kg</td> </tr> <tr> <td>8C10-E3</td> <td>10m</td> <td>3.0kg</td> </tr> <tr> <td>8C30-E3</td> <td>30m</td> <td>8.4kg</td> </tr> <tr> <td>8C50-E3</td> <td>50m</td> <td>13.8kg</td> </tr> </tbody> </table>	Model	Length	Weight	8C05-E3	5m	1.6kg	8C10-E3	10m	3.0kg	8C30-E3	30m	8.4kg	8C50-E3	50m	13.8kg	<p>M2 Two-cord, AT shield</p>  <p>Connector: NK27-21C 3/4-R, NK27-22C 3/4-R Cable: M202-8AT (black) Rubber bushing: AN3420-10(R1), 12(R1) + Heat Shrink Tube</p> <table border="1"> <thead> <tr> <th>Model</th> <th>Length</th> <th>Weight</th> </tr> </thead> <tbody> <tr> <td>8C10-M2</td> <td>10m</td> <td>1.7kg</td> </tr> <tr> <td>8C30-M2</td> <td>30m</td> <td>4.5kg</td> </tr> <tr> <td>8C50-M2</td> <td>50m</td> <td>7.3kg</td> </tr> </tbody> </table>	Model	Length	Weight	8C10-M2	10m	1.7kg	8C30-M2	30m	4.5kg	8C50-M2	50m	7.3kg	 <p>Connector: NK27-21C-3/4-R Cable: L-4E3-8P (black)</p> <table border="1"> <thead> <tr> <th>Model</th> <th>Length</th> <th>Weight</th> <th>Cable reel</th> </tr> </thead> <tbody> <tr> <td>8R30-E3</td> <td>30m</td> <td>18.1kg</td> <td>R380</td> </tr> <tr> <td>8R50-E3</td> <td>50m</td> <td>23.0kg</td> <td>R380</td> </tr> </tbody> </table>	Model	Length	Weight	Cable reel	8R30-E3	30m	18.1kg	R380	8R50-E3	50m	23.0kg	R380
	Model	Length	Weight																																							
8C05-E3	5m	1.6kg																																								
8C10-E3	10m	3.0kg																																								
8C30-E3	30m	8.4kg																																								
8C50-E3	50m	13.8kg																																								
Model	Length	Weight																																								
8C10-M2	10m	1.7kg																																								
8C30-M2	30m	4.5kg																																								
8C50-M2	50m	7.3kg																																								
Model	Length	Weight	Cable reel																																							
8R30-E3	30m	18.1kg	R380																																							
8R50-E3	50m	23.0kg	R380																																							
12 CH	<p>Connector: NK27-21C 7/8-R, NK27-22C 7/8-R Cable: L-4E3-12P (black) Rubber bushing: AN3420-16(R1)</p> <table border="1"> <thead> <tr> <th>Model</th> <th>Length</th> <th>Weight</th> </tr> </thead> <tbody> <tr> <td>12C05-E3</td> <td>5m</td> <td>2.1kg</td> </tr> <tr> <td>12C10-E3</td> <td>10m</td> <td>3.9kg</td> </tr> <tr> <td>12C30-E3</td> <td>30m</td> <td>11.1kg</td> </tr> <tr> <td>12C50-E3</td> <td>50m</td> <td>18.3kg</td> </tr> </tbody> </table>	Model	Length	Weight	12C05-E3	5m	2.1kg	12C10-E3	10m	3.9kg	12C30-E3	30m	11.1kg	12C50-E3	50m	18.3kg	<p>Connector: NK27-21C 3/4-R, NK27-22C 3/4-R Cable: M202-12AT (black) Rubber bushing: AN3420-10(R1), 12(R1) + Heat Shrink Tube</p> <table border="1"> <thead> <tr> <th>Model</th> <th>Length</th> <th>Weight</th> </tr> </thead> <tbody> <tr> <td>12C10-M2</td> <td>10m</td> <td>2.1kg</td> </tr> <tr> <td>12C30-M2</td> <td>30m</td> <td>5.8kg</td> </tr> <tr> <td>12C50-M2</td> <td>50m</td> <td>9.3kg</td> </tr> </tbody> </table>	Model	Length	Weight	12C10-M2	10m	2.1kg	12C30-M2	30m	5.8kg	12C50-M2	50m	9.3kg	 <p>Connector: NK27-21C-7/8-R Cable: L-4E3-12P (black)</p> <table border="1"> <thead> <tr> <th>Model</th> <th>Length</th> <th>Weight</th> <th>Cable reel</th> </tr> </thead> <tbody> <tr> <td>12R30-E3</td> <td>30m</td> <td>20.6kg</td> <td>R380</td> </tr> <tr> <td>12R50-E3</td> <td>50m</td> <td>30.4kg</td> <td>R460</td> </tr> </tbody> </table>	Model	Length	Weight	Cable reel	12R30-E3	30m	20.6kg	R380	12R50-E3	50m	30.4kg	R460
	Model	Length	Weight																																							
12C05-E3	5m	2.1kg																																								
12C10-E3	10m	3.9kg																																								
12C30-E3	30m	11.1kg																																								
12C50-E3	50m	18.3kg																																								
Model	Length	Weight																																								
12C10-M2	10m	2.1kg																																								
12C30-M2	30m	5.8kg																																								
12C50-M2	50m	9.3kg																																								
Model	Length	Weight	Cable reel																																							
12R30-E3	30m	20.6kg	R380																																							
12R50-E3	50m	30.4kg	R460																																							
16 CH	<p>Connector: FK37-21C 7/8-R, FK37-22C 7/8-R Cable: L-4E3-16P (black) Rubber bushing: AN3420-16(R1)</p> <table border="1"> <thead> <tr> <th>Model</th> <th>Length</th> <th>Weight</th> </tr> </thead> <tbody> <tr> <td>16C05-E3</td> <td>5m</td> <td>2.6kg</td> </tr> <tr> <td>16C10-E3</td> <td>10m</td> <td>4.9kg</td> </tr> <tr> <td>16C30-E3</td> <td>30m</td> <td>14.1kg</td> </tr> <tr> <td>16C50-E3</td> <td>50m</td> <td>23.3kg</td> </tr> </tbody> </table>	Model	Length	Weight	16C05-E3	5m	2.6kg	16C10-E3	10m	4.9kg	16C30-E3	30m	14.1kg	16C50-E3	50m	23.3kg	<p>Connector: FK37-21C 7/8-R, FK37-22C 7/8-R Cable: M202-16AT (black) Rubber bushing: AN3420-10(R1), 12(R1), 16(R1)</p> <table border="1"> <thead> <tr> <th>Model</th> <th>Length</th> <th>Weight</th> </tr> </thead> <tbody> <tr> <td>16C10-M2</td> <td>10m</td> <td>2.7kg</td> </tr> <tr> <td>16C30-M2</td> <td>30m</td> <td>7.5kg</td> </tr> <tr> <td>16C50-M2</td> <td>50m</td> <td>12.3kg</td> </tr> </tbody> </table>	Model	Length	Weight	16C10-M2	10m	2.7kg	16C30-M2	30m	7.5kg	16C50-M2	50m	12.3kg	 <p>Connector: FK37-21C-7/8-R Cable: L-4E3-16P (black)</p> <table border="1"> <thead> <tr> <th>Model</th> <th>Length</th> <th>Weight</th> <th>Cable reel</th> </tr> </thead> <tbody> <tr> <td>16R30-E3</td> <td>30m</td> <td>24.1kg</td> <td>R380</td> </tr> <tr> <td>16R50-E3</td> <td>50m</td> <td>36.1kg</td> <td>R460</td> </tr> </tbody> </table>	Model	Length	Weight	Cable reel	16R30-E3	30m	24.1kg	R380	16R50-E3	50m	36.1kg	R460
	Model	Length	Weight																																							
16C05-E3	5m	2.6kg																																								
16C10-E3	10m	4.9kg																																								
16C30-E3	30m	14.1kg																																								
16C50-E3	50m	23.3kg																																								
Model	Length	Weight																																								
16C10-M2	10m	2.7kg																																								
16C30-M2	30m	7.5kg																																								
16C50-M2	50m	12.3kg																																								
Model	Length	Weight	Cable reel																																							
16R30-E3	30m	24.1kg	R380																																							
16R50-E3	50m	36.1kg	R460																																							
24 CH	<p>Connector: <D/MS3106B32A-10S+D/MS3057-20A(R1)> x 2 Cable: L-4E3-24P (black) Rubber bushing: AN3420-20(R1)</p> <table border="1"> <thead> <tr> <th>Model</th> <th>Length</th> <th>Weight</th> </tr> </thead> <tbody> <tr> <td>24C05-E3</td> <td>5m</td> <td>4.3kg</td> </tr> <tr> <td>24C10-E3</td> <td>10m</td> <td>7.7kg</td> </tr> <tr> <td>24C30-E3</td> <td>30m</td> <td>21.7kg</td> </tr> <tr> <td>24C50-E3</td> <td>50m</td> <td>35.7kg</td> </tr> </tbody> </table> <p>Extension Cord Connector: <D/MS3101A32A-10P+D/MS3057-20A(R1)> x 2 Cable: L-4E3-24P (black)</p> <table border="1"> <thead> <tr> <th>Model</th> <th>24C005-E3MS22</th> </tr> </thead> </table>	Model	Length	Weight	24C05-E3	5m	4.3kg	24C10-E3	10m	7.7kg	24C30-E3	30m	21.7kg	24C50-E3	50m	35.7kg	Model	24C005-E3MS22	<p>Connector: <D/MS3106B32A-10S+D/MS3057-20A(R1)> x 2 Cable: M202-24AT (black) Rubber bushing: AN3420-16(R1), 20(R1) + Heat Shrink Tube</p> <table border="1"> <thead> <tr> <th>Model</th> <th>Length</th> <th>Weight</th> </tr> </thead> <tbody> <tr> <td>24C10-M2</td> <td>10m</td> <td>4.0kg</td> </tr> <tr> <td>24C30-M2</td> <td>30m</td> <td>10.4kg</td> </tr> <tr> <td>24C50-M2</td> <td>50m</td> <td>16.8kg</td> </tr> </tbody> </table>	Model	Length	Weight	24C10-M2	10m	4.0kg	24C30-M2	30m	10.4kg	24C50-M2	50m	16.8kg	 <p>Connector: D/MS3106B32A-10S Cable: L-4E3-24P (black)</p> <table border="1"> <thead> <tr> <th>Model</th> <th>Length</th> <th>Weight</th> <th>Cable reel</th> </tr> </thead> <tbody> <tr> <td>24R30-E3</td> <td>30m</td> <td>34.6kg</td> <td>R460</td> </tr> </tbody> </table>	Model	Length	Weight	Cable reel	24R30-E3	30m	34.6kg	R460		
	Model	Length	Weight																																							
24C05-E3	5m	4.3kg																																								
24C10-E3	10m	7.7kg																																								
24C30-E3	30m	21.7kg																																								
24C50-E3	50m	35.7kg																																								
Model	24C005-E3MS22																																									
Model	Length	Weight																																								
24C10-M2	10m	4.0kg																																								
24C30-M2	30m	10.4kg																																								
24C50-M2	50m	16.8kg																																								
Model	Length	Weight	Cable reel																																							
24R30-E3	30m	34.6kg	R460																																							
32 CH	<p>Connector: <D/MS3106B36-73S+D/MS3057-24A(R1)> x 2 Cable: M202-32AT (black) Rubber bushing: AN3420-16(R1), 20(R1), 24(R1)</p> <table border="1"> <thead> <tr> <th>Model</th> <th>Length</th> <th>Weight</th> </tr> </thead> <tbody> <tr> <td>32C10-M2</td> <td>10m</td> <td>4.8kg</td> </tr> <tr> <td>32C30-M2</td> <td>30m</td> <td>13.1kg</td> </tr> <tr> <td>32C50-M2</td> <td>50m</td> <td>21.0kg</td> </tr> </tbody> </table> <p>Extension Cord Connector: <D/MS3101A36-73P+D/MS3057-24A(R1)> x 2 Cable: M202-32AT (black)</p> <table border="1"> <thead> <tr> <th>Model</th> <th>32C005-M2MS22</th> </tr> </thead> </table>	Model	Length	Weight	32C10-M2	10m	4.8kg	32C30-M2	30m	13.1kg	32C50-M2	50m	21.0kg	Model	32C005-M2MS22	<p>Connector: <D/MS3101A36-73P+D/MS3057-24A(R1)> x 2 Cable: M202-32AT (black)</p> <table border="1"> <thead> <tr> <th>Model</th> <th>Length</th> <th>Weight</th> </tr> </thead> <tbody> <tr> <td>32C10-M2</td> <td>10m</td> <td>4.8kg</td> </tr> <tr> <td>32C30-M2</td> <td>30m</td> <td>13.1kg</td> </tr> <tr> <td>32C50-M2</td> <td>50m</td> <td>21.0kg</td> </tr> </tbody> </table>	Model	Length	Weight	32C10-M2	10m	4.8kg	32C30-M2	30m	13.1kg	32C50-M2	50m	21.0kg	<div style="display: flex; justify-content: space-around;"> <div> <p>Website</p>  <p>Snake Trunk</p> </div> <div> <p>Website</p>  <p>Cable Reel Snakes</p> </div> <div> <p>Website</p>  <p>Fantail</p> </div> <div> <p>Website</p>  <p>Junction Box</p> </div> </div> <div style="border: 1px solid black; padding: 5px; margin-top: 10px;"> <p>□ ○ : Female ■ ● : Male</p> </div>													
	Model	Length	Weight																																							
32C10-M2	10m	4.8kg																																								
32C30-M2	30m	13.1kg																																								
32C50-M2	50m	21.0kg																																								
Model	32C005-M2MS22																																									
Model	Length	Weight																																								
32C10-M2	10m	4.8kg																																								
32C30-M2	30m	13.1kg																																								
32C50-M2	50m	21.0kg																																								

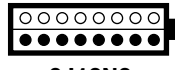
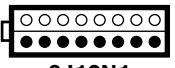
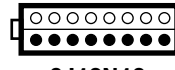
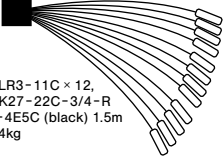
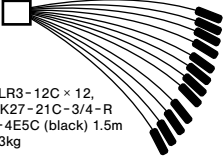
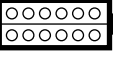
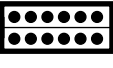
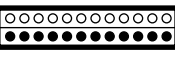
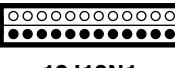
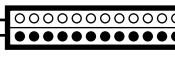
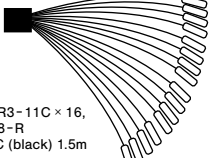
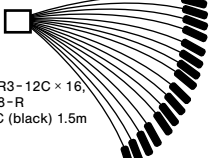
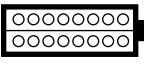
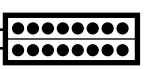
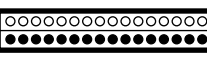
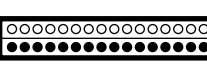
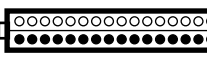
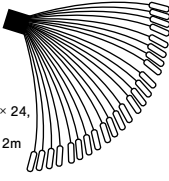
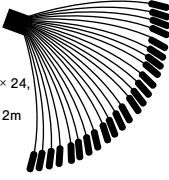
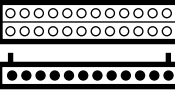
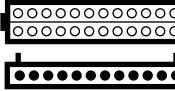
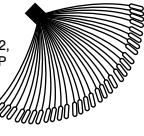
Note: Connecting cables 24C005-E3MS22 and 32C005-M2MS22 are to be used to interconnect snake trunks only and they do not mate with our other standard snake system.

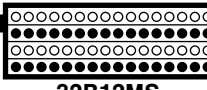
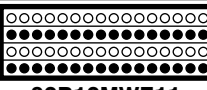
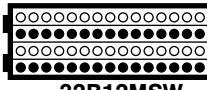
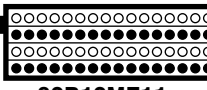
Fantails	Junction Boxes		
<p>8S1N2 Connector: XLR3-11C x 8, NK27-22C-3/4-R Cable: L-4E6S (black) 1.5m Weight: 1.1kg</p>  <p>8S2N1 Connector: XLR3-12C x 8, NK27-21C-3/4-R Cable: L-4E6S (black) 1.5m Weight: 1.0kg</p> 	<p>Single XLR per channel</p> <p>8B1N2 Connector: XLR3-31-F77 x 8, NK27-32S-R x 1 Weight: 0.9kg</p>  <p>8B2N1 Connector: XLR3-32-F77 x 8, NK27-31S-R x 1 Weight: 1.1kg</p> 	<p>Parallel XLR per channel</p> <p>8J12N2 Connector: XLR3-31-F77 x 8, XLR3-32-F77 x 8, NK27-32S-R x 1 Weight: 1.5kg</p>  <p>8J12N1 Connector: XLR3-31-F77 x 8, XLR3-32-F77 x 8, NK27-31S-R x 1 Weight: 1.5kg</p> 	<p>Parallel XLR per channel MultiPin feed through</p> <p>8J12N12 Connector: XLR3-31-F77 x 8, XLR3-32-F77 x 8, wNK27-31S-R x 1, NK27-32S-R x 1 Weight: 1.6kg</p> 
<p>12S1N2 Connector: XLR3-11C x 12, NK27-22C-3/4-R Cable: L-4E5C (black) 1.5m Weight: 1.4kg</p>  <p>12S2N1 Connector: XLR3-12C x 12, NK27-21C-3/4-R Cable: L-4E5C (black) 1.5m Weight: 1.3kg</p> 	<p>12B1N2 Connector: XLR3-31-F77 x 12, NK27-32S-R x 1 Weight: 1.3kg</p>  <p>12B2N1 Connector: XLR3-32-F77 x 12, NK27-31S-R x 1 Weight: 1.2kg</p> 	<p>12J12N2 Connector: XLR3-31-F77 x 12, XLR3-32-F77 x 12, NK27-32S-R x 1 Weight: 2.1kg</p>  <p>12J12N1 Connector: XLR3-31-F77 x 12, XLR3-32-F77 x 12, NK27-31S-R x 1 Weight: 2.1kg</p> 	<p>12J12N12 Connector: XLR3-31-F77 x 12, XLR3-32-F77 x 12, NK27-31S-R x 1, NK27-32S-R x 1 Weight: 2.2kg</p> 
<p>16S1F2 Connector: XLR3-11C x 16, FK37-22C-7/8-R Cable: L-4E5C (black) 1.5m Weight: 1.9kg</p>  <p>16S2F1 Connector: XLR3-12C x 16, FK37-21C-7/8-R Cable: L-4E5C (black) 1.5m Weight: 1.7kg</p> 	<p>16B1F2 Connector: XLR3-31-F77 x 16, FK37-32S-R x 1 Weight: 1.6kg</p>  <p>16B2F1 Connector: XLR3-32-F77 x 16, FK37-31S-R x 1 Weight: 1.3kg</p> 	<p>16J12F2 Connector: XLR3-31-F77 x 16, XLR3-32-F77 x 16, FK37-32S-R x 1 Weight: 2.5kg</p>  <p>16J12F1 Connector: XLR3-31-F77 x 16, XLR3-32-F77 x 16, FK37-31S-R x 1 Weight: 2.5kg</p> 	<p>16J12F12 Connector: XLR3-31-F77 x 16, XLR3-32-F77 x 16, FK37-31S-R x 1, FK37-32S-R x 1 Weight: 2.6kg</p> 
<p>24S1MS2 Connector: XLR3-11C x 24, D/MS3101A32A-10P Cable: L-4E5C (black) 2m</p>  <p>24S2MS2 Connector: XLR3-12C x 24, D/MS3101A32A-10P Cable: L-4E5C (black) 2m</p> 	<p>24B12MS Connector: XLR3-31-F77 x 24 (on top), XLR3-32-F77 x 24 (12 on each side), D/MS3102A32A-10P Weight: 2.7kg</p> 	<p>24B12MSW Connector: XLR3-31-F77 x 24 (on top), XLR3-32-F77 x 24 (12 on each side), D/MS3102A32A-10P x 2 Weight: 3.0kg</p> 	
<p>32S1MS2 Connector: XLR3-11C x 32, D/MS3101A36-73P Cable: L-4E5C (black) 2m</p>  <p>32S2MS2 Connector: XLR3-12C x 32, D/MS3101A36-73P Cable: L-4E5C (black) 2m</p> 	<p>32B12MS Connector: XLR3-31-F77 x 32, XLR3-32-F77 x 32, D/MS3102A36-73P Weight: 5.3kg</p>  <p>32B12MWF11 Connector: XLR3-31-F77 x 32, XLR3-32-F77 x 32, D/MS3102A36-73P x 2, FK37-31S-R x 2 Weight: 6.0kg</p> 	<p>32B12MSW Connector: XLR3-31-F77 x 32, XLR3-32-F77 x 32, D/MS3102A36-73P x 2 Weight: 5.5kg</p>  <p>32B12MF11 Connector: XLR3-31-F77 x 32, XLR3-32-F77 x 32, D/MS3102A36-73P x 1, FK37-31S-R x 2 Weight: 5.7kg</p> 	

IP Connectivity Products

Technical Trend

Fiber-Optic Systems

Connectors

Cables

Panels & Patchbays

Multichannel Systems

Cable Assemblies

Multichannel Systems

Pin Assignments, Reels

Multichannel Connector Pin Assignments

Ch No.	Cable Unit Identification		32ch		24ch		16ch		8ch / 12ch		
	L-4E3	M202	D/MS3102A36-73 D/MS3106B36-73		D/MS3102A32A-10 D/MS3106B32A-10		FK37		NK27		
	Spiral Marker Color	Insulator Color Identifying Color Common Identifying Color	HOT	COLD	HOT	COLD	HOT	COLD	HOT	COLD	
1	RED	RED • WHT	A	B	A	B	1	2	1	3	
2	BLU	BLU •	C	D	C	D	3	4	4	5	
3	YEL	YEL •	F	H	F	G	5	6	6	7	
4	GRN	GRN •	J	K	H	J	8	9	8	9	
5	BRN	BRN •	L	M	K	L	10	11	11	12	
6	N/A	GRY •	N	P	N	O	12	13	13	14	
7	BLU • BLK	BLU • BLK	R	S	P	R	14	15	15	16	
8	YEL • BLK	YEL •	T	U	S	T	16	17	17	18	
9	GRN • BLK	GRN •	V	W	U	V	21	22	19	20	
10	BRN • BLK	BRN •	Y	Z	X	Y	23	24	22	23	
11	BLK	GRY •	a	b	Z	a	25	26	24	25	
12	BLU • ORN	BLU • ORN	c	d	b	c	27	28	26	27	
13	YEL • ORN	YEL •	f	g	d	e	29	30	SHIELD		
14	GRN • ORN	GRN •	h	i	g	h	32	33	10		
15	BRN • ORN	BRN •	j	k	j	k	34	35			
16	ORN	GRY •	m	n	m	n	36	37			
17	BLU • PNK	BLU • PNK	u	v	p	q	SHIELD				
18	YEL • PNK	YEL •	w	x	s	t	19				
19	GRN • PNK	GRN •	y	z	u	v					
20	BRN • PNK	BRN •	AA	AB	w	x					
21	PNK	GRY •	AC	AD	AB	z					
22	BLU • WHT	BLU • RED	AE	AF	AA	AC					
23	YEL • WHT	YEL •	AH	AJ	AD	AF					
24	GRN • WHT	GRN •	AL	AM	AG	AE					
25	—	BRN •	AN	AP	SHIELD						
26	—	GRY •	AR	AS	E						
27	—	YEL • BLU	AT	AU							
28	—	GRN •	AV	AW							
29	—	BRN •	AX	AY							
30	—	GRN • YEL	AZ	BA							
31	—	BRN •	BC	BD							
32	—	GRY •	BE	BF							
			SHIELD								
			E	q	t						
			X	r	AK						
			p	s	BB						

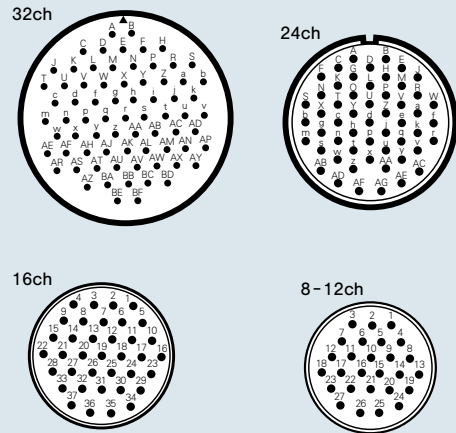

■ Connection Method

L-4E3 Types:

Identify the channel number by the color of the spiral marker on the inner jacket (gray). The unit is 4-core construction and the insulator colors are blue, blue, white, and white. Connect these with the same colored cores, so that the blue cores are connected to Hot and the white cores to Cold.

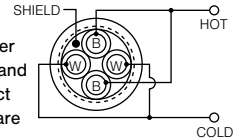

M202 Types:

The unit is 2-core construction, with the channel number identified by the insulator color (a combination of the identifying color and common identifying color). Connect the identifying color core to Hot, and the common identifying color core to Cold.

■ Connections to XLR Connectors

Polarity	HOT	COLD	SHIELD
Pin No.	2	3	1

Lightweight Cable Reels

Lightweight plastic cable reels made by Schill™

Model	Flange Dim.	Description	Weight
RGT310.RM	310 mm	with auxiliary reel	1.8 kg
RGT380.RM	380 mm		4.8 kg
RGT310.MFK	310 mm	with latching door	1.4 kg
RGT380.MFK	380 mm		4.3 kg

Color: dark blue

- Canare and Schill™ collaboration
- *Schill™ is a trademark of Schill GmbH & Co. KG
- Easy to carry around
- High quality resin: durable, weatherproof and lightweight.
- Locking brake
- Latching door type (MFK) allows you to store cable connector inside reel.
- Canare special colored flange
- Rough estimate of maximum cable lengths (cable O.D.)
- RGT310: L-4E6S 120 m (6 mm)
- RGT380: L-5CFW 130 m (7.7 mm)
- RJC6A-4P-SFM 110m (8.6 mm)
- LF-2SM9N 100m (9.2 mm)



RGT310.RM



RGT380.MFK



RGT380.MFK
door open

Website

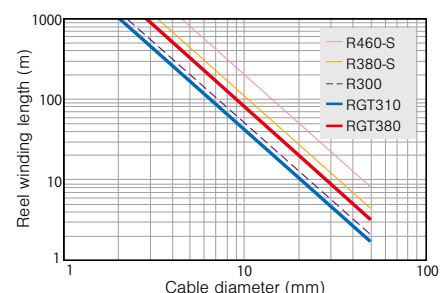
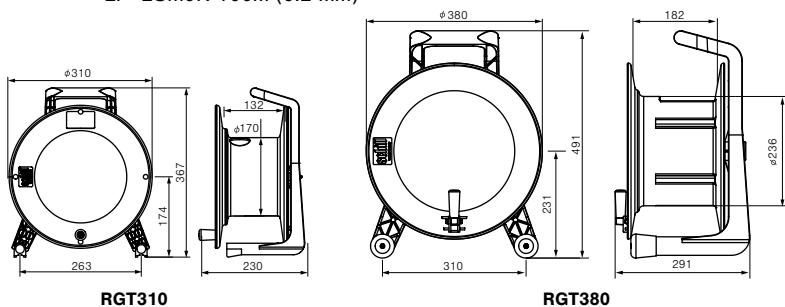

Cable winding length reference chart

Cable Reels

Dependable cable reels Dependable steel reels with 3-speed brake

Model	Flange Dim.	Description	Feature	Weight
R300-S	300 mm	with auxiliary reel	stackable	4.6 kg
R380-S	380 mm		w/caster	8.3 kg
R460-S	460 mm		w/caster	9.9 kg
R300	300 mm	cable hole on hub (no exit)	stackable	4.3 kg
R300-L	300 mm	connector trench on hub (no holes)	stackable	4.4 kg
R300-CN	300 mm	XLR3 receptacles on hub and flange	stackable	4.6 kg
R300-BN	300 mm	BNC receptacles on hub and flange	stackable	4.6 kg

Color: black

- 3-speed brake : lock/soft/free
- Oilless bearing
- Tubular steel E brace construction
- Parallel wired M & F XLR3s for genderless connection (R300-CN)

Website



R460-S



R300-S

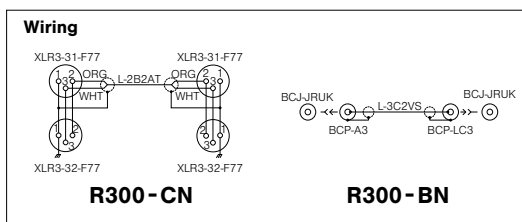

3-speed brake

Reels with Cable Assemblies

Cable reels with detachable cables

Model	Cable reel	Description			Weight (kg)
		Inner end	Cable	Outer end	
CR100-CN	R300-CN	XLR3-12C	L-4E6S(100m)	XLR3-11C	9.6
CR100-S	R300-S	XLR3-12C	L-4E6S(100m)	XLR3-11C	9.6
CR90-BN	R300-BN	BCP-H5B	L-5C2VS(90m)	BCP-H5B	10.5

Website



CR100-CN

Dimensions

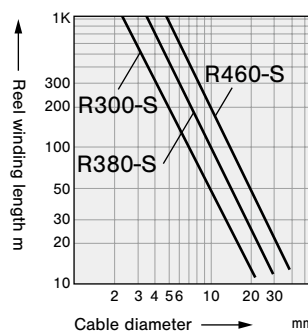
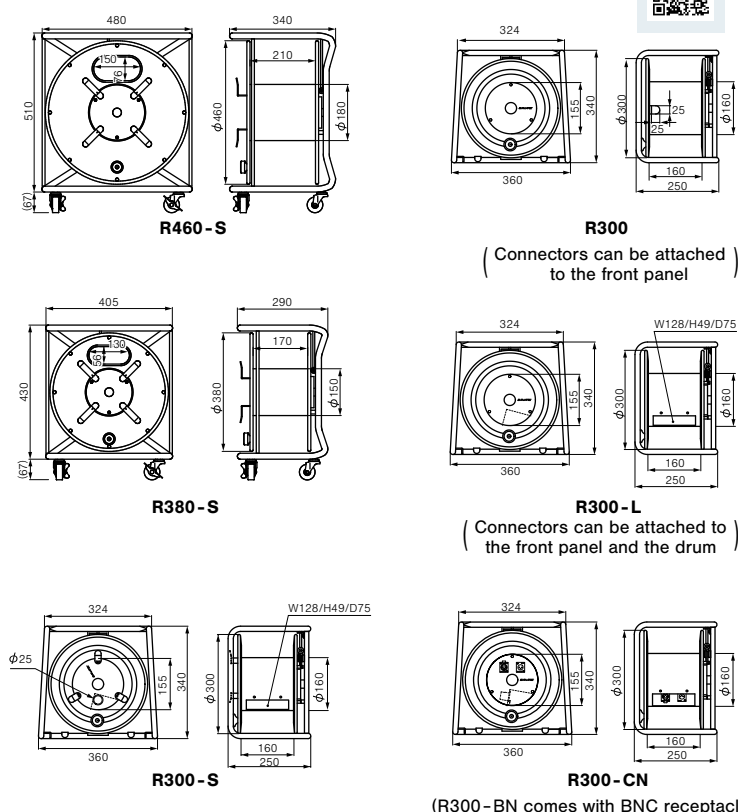

Cable winding length reference chart

<Wind length conversion formula>

$$R300-S \text{ (S, L, CN)} \quad L = \frac{8448}{D^2} \times 0.6 \text{ (m)} \quad R460-S \quad L = \frac{33852}{D^2} \times 0.6 \text{ (m)}$$

$$R380-S \quad L = \frac{18207}{D^2} \times 0.6 \text{ (m)} \quad \begin{matrix} D: \text{cable outer diameter (mm)} \\ L: \text{wind length} \end{matrix}$$

(R300-BN comes with BNC receptacles)

IP Connectivity Products

Technical Trend

Fiber-Optic Systems

Connectors

Cables

Panels & Patchbays

Multichannel Systems

Cable Assemblies